

# DATA SHEET



## Three Phase Induction Motor - Squirrel Cage

Customer :								
Product line	: ODP NEMA Premium Efficiency Three-Phase	Product code :	10869627					
		Catalog # :	20018OT3G445T					
Frame	: 444/5T	Cooling method	: IC01 - ODP					
Insulation class	: F	Mounting	: F-1					
Duty cycle	: Cont.(S1)	Rotation <sup>1</sup>	: Both (CW and CCW)					
Ambient temperature	: -20°C to +40°C	Starting method	: Direct On Line					
Altitude	: 1000 m.a.s.l.	Approx. weight <sup>2</sup>	: 1453 lb					
Protection degree	: IP23	Moment of inertia (J)	: 49.5 sq.ft.lb					
Design	: B							
Output [HP]	200	175	175	175	200	200	200	
Poles	4	4	4	4	4	4	4	
Frequency [Hz]	60	50	50	50	50	50	50	
Rated voltage [V]	460	380	400	415	380	400	415	
Rated current [A]	229	250	240	237	286	275	265	
L. R. Amperes [A]	1397	1575	1680	1778	1602	1705	1776	
LRC [A]	6.1x(Code F)	6.3x(Code G)	7.0x(Code H)	7.5x(Code J)	5.6x(Code F)	6.2x(Code G)	6.7x(Code H)	
No load current [A]	75.0	91.5	101	111	91.5	101	111	
Rated speed [RPM]	1780	1480	1480	1485	1480	1480	1485	
Slip [%]	1.11	1.33	1.33	1.00	1.33	1.33	1.00	
Rated torque [ft.lb]	582	613	613	611	700	700	698	
Locked rotor torque [%]	200	210	220	240	180	190	210	
Breakdown torque [%]	229	250	290	320	220	250	280	
Service factor	1.15	1.15	1.15	1.15	1.15	1.15	1.15	
Temperature rise	80 K	80 K	80 K	80 K	80 K	80 K	80 K	
Locked rotor time	28s (cold) 16s (hot)	23s (cold) 13s (hot)	21s (cold) 12s (hot)	19s (cold) 11s (hot)	23s (cold) 13s (hot)	21s (cold) 12s (hot)	19s (cold) 11s (hot)	
Noise level <sup>2</sup>	78.0 dB(A)							
Efficiency (%)	25%	95.3	90.9	91.2	91.2	93.2	93.3	92.5
	50%	95.4	92.5	92.6	92.6	93.4	93.4	93.4
	75%	95.8	94.0	94.2	94.2	93.6	93.6	94.0
	100%	95.8	95.6	95.6	95.6	93.7	93.6	94.9
Power Factor	25%	0.50	0.47	0.42	0.38	0.51	0.46	0.42
	50%	0.76	0.71	0.67	0.63	0.76	0.72	0.68
	75%	0.83	0.81	0.78	0.75	0.82	0.80	0.78
	100%	0.86	0.84	0.83	0.81	0.85	0.84	0.83
Bearing type	: Drive end 6319 C3	: Non drive end 6316 C3	Foundation loads					
Sealing	: Without	: Without	Max. traction	: 4553 lb				
	: Bearing Seal	: Bearing Seal	Max. compression	: 6006 lb				
Lubrication interval	: 20000 h	: 20000 h						
Lubricant amount	: 45 g	: 34 g						
Lubricant type	: Mobil Polyrex EM							
Notes								
This revision replaces and cancel the previous one, which must be eliminated. (1) Looking the motor from the shaft end. (2) Measured at 1m and with tolerance of +3dB(A). (3) Approximate weight subject to changes after manufacturing process. (4) At 100% of full load.				These are average values based on tests with sinusoidal power supply, subject to the tolerances stipulated in NEMA MG-1.				
Rev.	Changes Summary			Performed	Checked	Date		
Performed by								
Checked by					Page	Revision		
Date	06/11/2019				1 / 36			

# TORQUE AND CURRENT VS SPEED CURVE

Three Phase Induction Motor - Squirrel Cage



Customer :

Product line : ODP NEMA Premium Efficiency  
Three-Phase

Product code : 10869627

Catalog # : 20018OT3G445T

TORQUE AND CURRENT VS SPEED CURVE

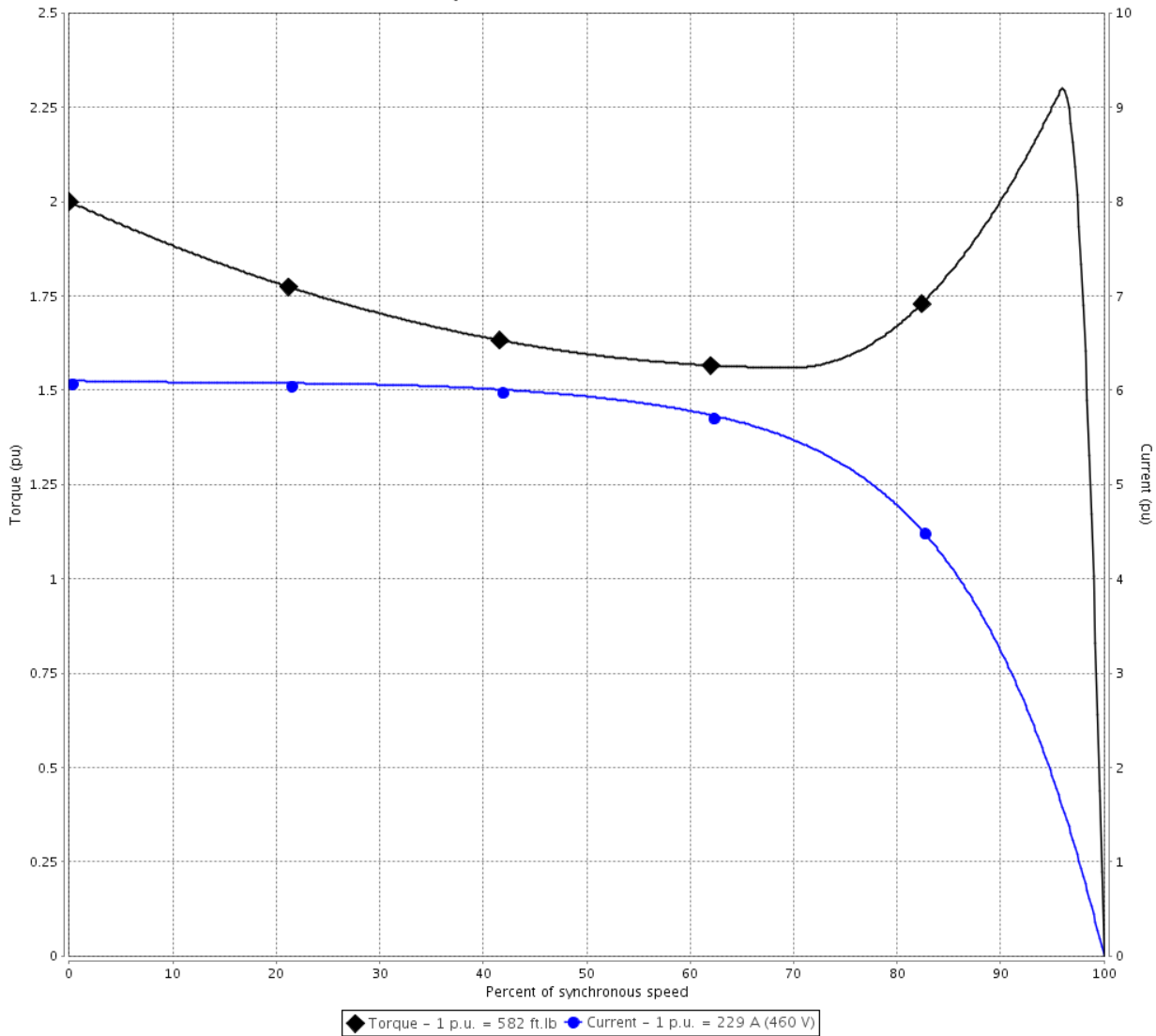

Performance : 460 V 60 Hz 4P

Rated current	: 229 A	Moment of inertia (J)	: 49.5 sq.ft.lb
LRC	: 6.1	Duty cycle	: Cont.(S1)
Rated torque	: 582 ft.lb	Insulation class	: F
Locked rotor torque	: 200 %	Service factor	: 1.15
Breakdown torque	: 229 %	Temperature rise	: 80 K
Rated speed	: 1780 rpm	Design	: B

Locked rotor time : 28s (cold) 16s (hot)

Rev.	Changes Summary	Performed	Checked	Date
Performed by			Page 2 / 36	Revision
Checked by				
Date	06/11/2019			

# TORQUE AND CURRENT VS SPEED CURVE



## Three Phase Induction Motor - Squirrel Cage

Customer :

Product line : ODP NEMA Premium Efficiency Three-Phase

Product code : 10869627

Catalog # : 20018OT3G445T

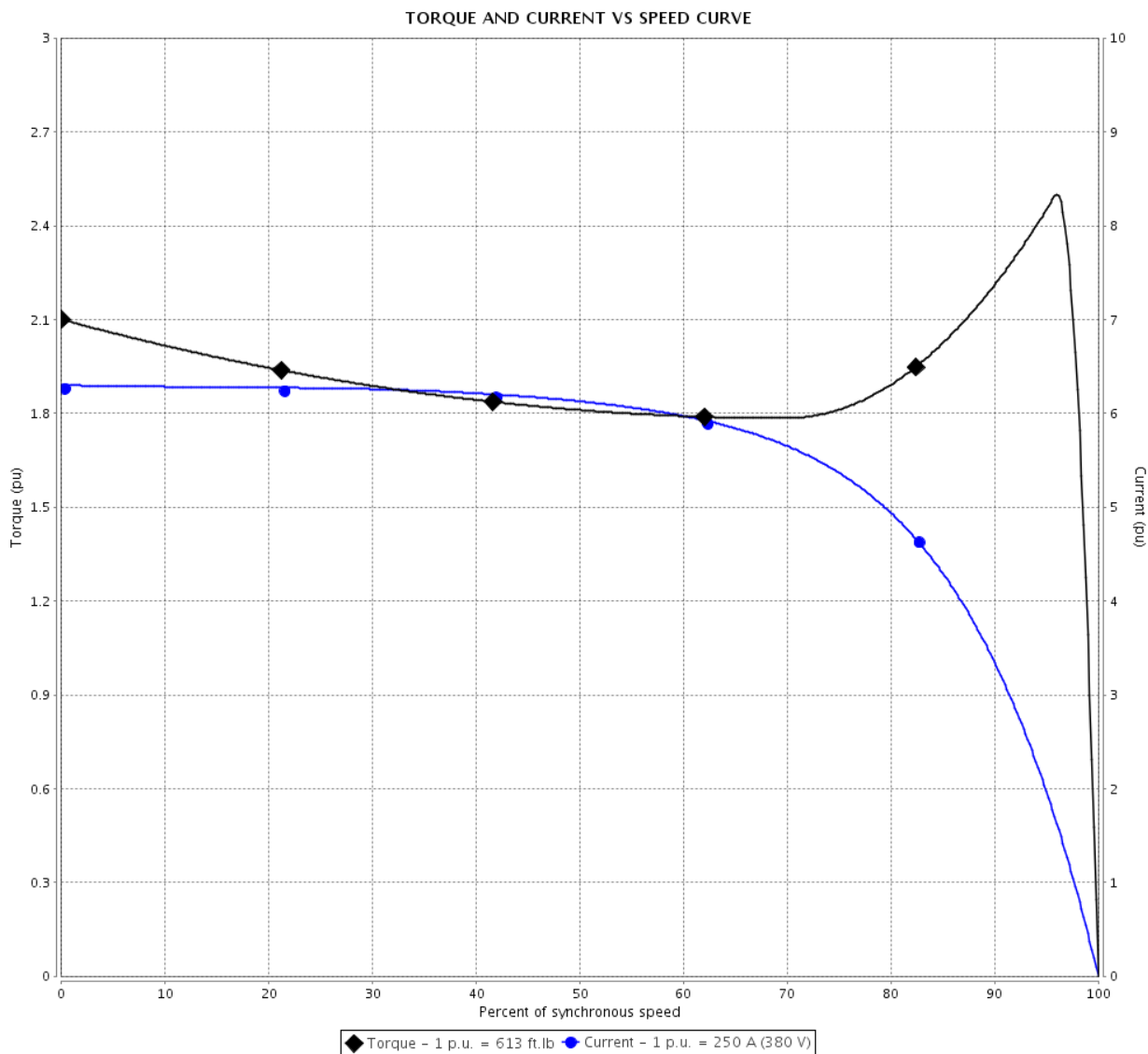

Performance : 380 V 50 Hz 4P IE3

Rated current	: 250 A	Moment of inertia (J)	: 49.5 sq.ft.lb
LRC	: 6.3	Duty cycle	: Cont.(S1)
Rated torque	: 613 ft.lb	Insulation class	: F
Locked rotor torque	: 210 %	Service factor	: 1.15
Breakdown torque	: 250 %	Temperature rise	: 80 K
Rated speed	: 1480 rpm	Design	: B

Locked rotor time : 23s (cold) 13s (hot)

Rev.	Changes Summary	Performed	Checked	Date
Performed by			Page	Revision
Checked by			3 / 36	
Date	06/11/2019			

# TORQUE AND CURRENT VS SPEED CURVE

## Three Phase Induction Motor - Squirrel Cage



Customer :

Product line : ODP NEMA Premium Efficiency  
Three-Phase

Product code : 10869627

Catalog # : 20018OT3G445T

TORQUE AND CURRENT VS SPEED CURVE

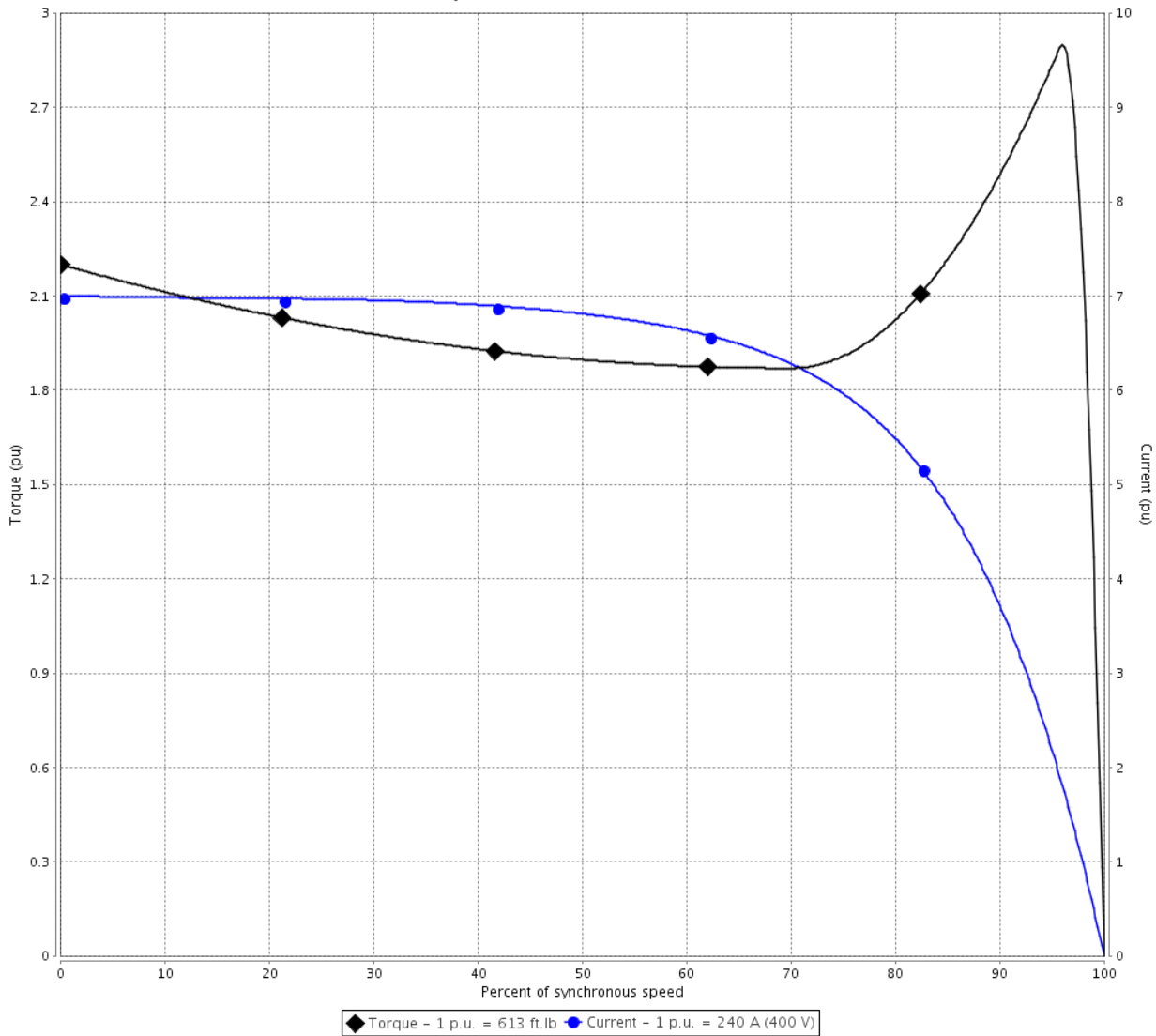

Performance : 400 V 50 Hz 4P IE3

Rated current	: 240 A	Moment of inertia (J)	: 49.5 sq.ft.lb
LRC	: 7.0	Duty cycle	: Cont.(S1)
Rated torque	: 613 ft.lb	Insulation class	: F
Locked rotor torque	: 220 %	Service factor	: 1.15
Breakdown torque	: 290 %	Temperature rise	: 80 K
Rated speed	: 1480 rpm	Design	: B

Locked rotor time : 21s (cold) 12s (hot)

Rev.	Changes Summary	Performed	Checked	Date
Performed by			Page 4 / 36	Revision
Checked by				
Date	06/11/2019			

# TORQUE AND CURRENT VS SPEED CURVE



## Three Phase Induction Motor - Squirrel Cage

Customer :

Product line : ODP NEMA Premium Efficiency  
Three-Phase

Product code : 10869627

Catalog # : 20018OT3G445T

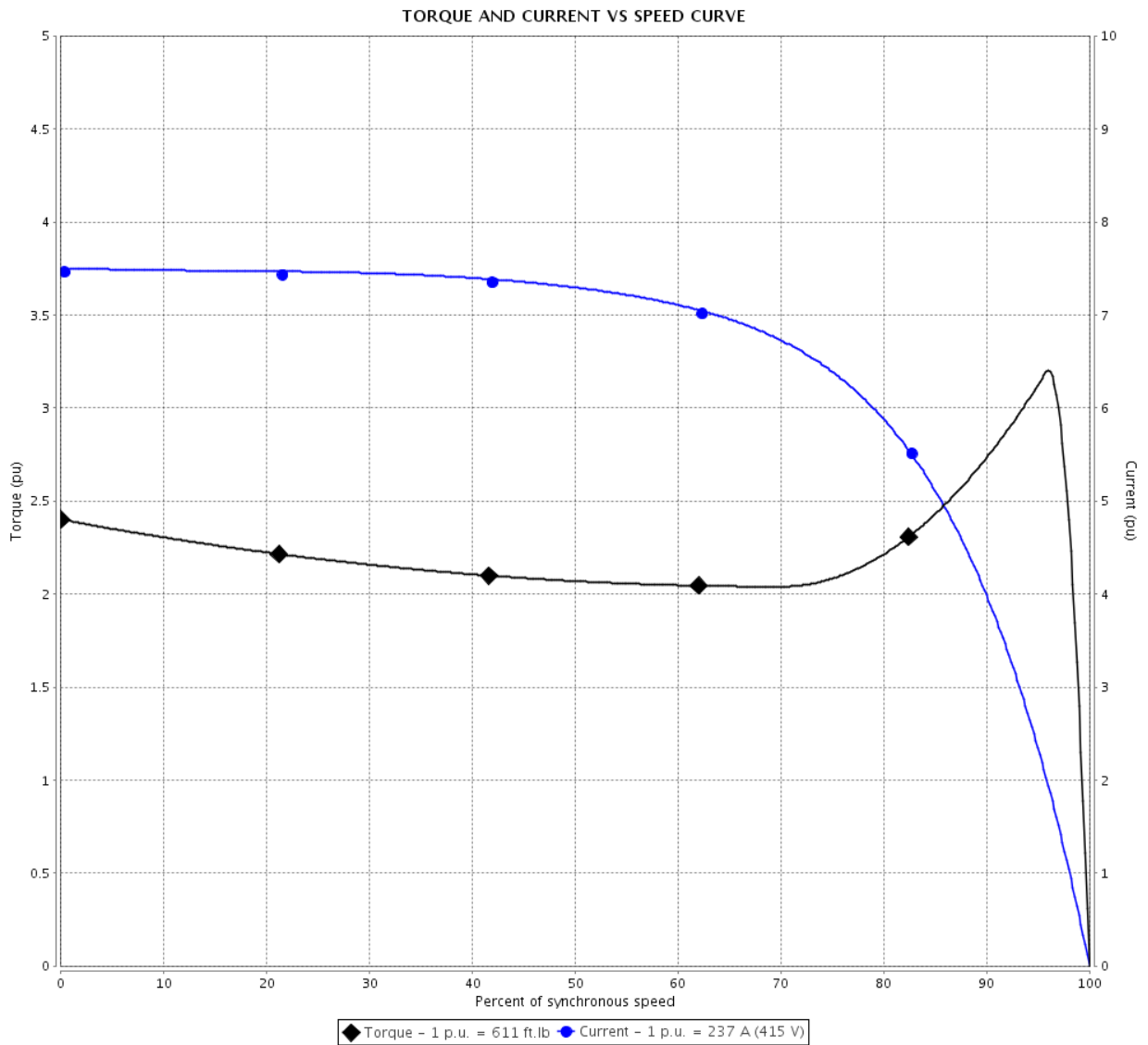

Performance : 415 V 50 Hz 4P IE3

Rated current	: 237 A	Moment of inertia (J)	: 49.5 sq.ft.lb
LRC	: 7.5	Duty cycle	: Cont.(S1)
Rated torque	: 611 ft.lb	Insulation class	: F
Locked rotor torque	: 240 %	Service factor	: 1.15
Breakdown torque	: 320 %	Temperature rise	: 80 K
Rated speed	: 1485 rpm	Design	: B

Locked rotor time : 19s (cold) 11s (hot)

Rev.	Changes Summary	Performed	Checked	Date
Performed by			Page	Revision
Checked by			5 / 36	
Date	06/11/2019			

# TORQUE AND CURRENT VS SPEED CURVE

Three Phase Induction Motor - Squirrel Cage



Customer :

Product line : ODP NEMA Premium Efficiency  
Three-Phase

Product code : 10869627

Catalog # : 20018OT3G445T

TORQUE AND CURRENT VS SPEED CURVE

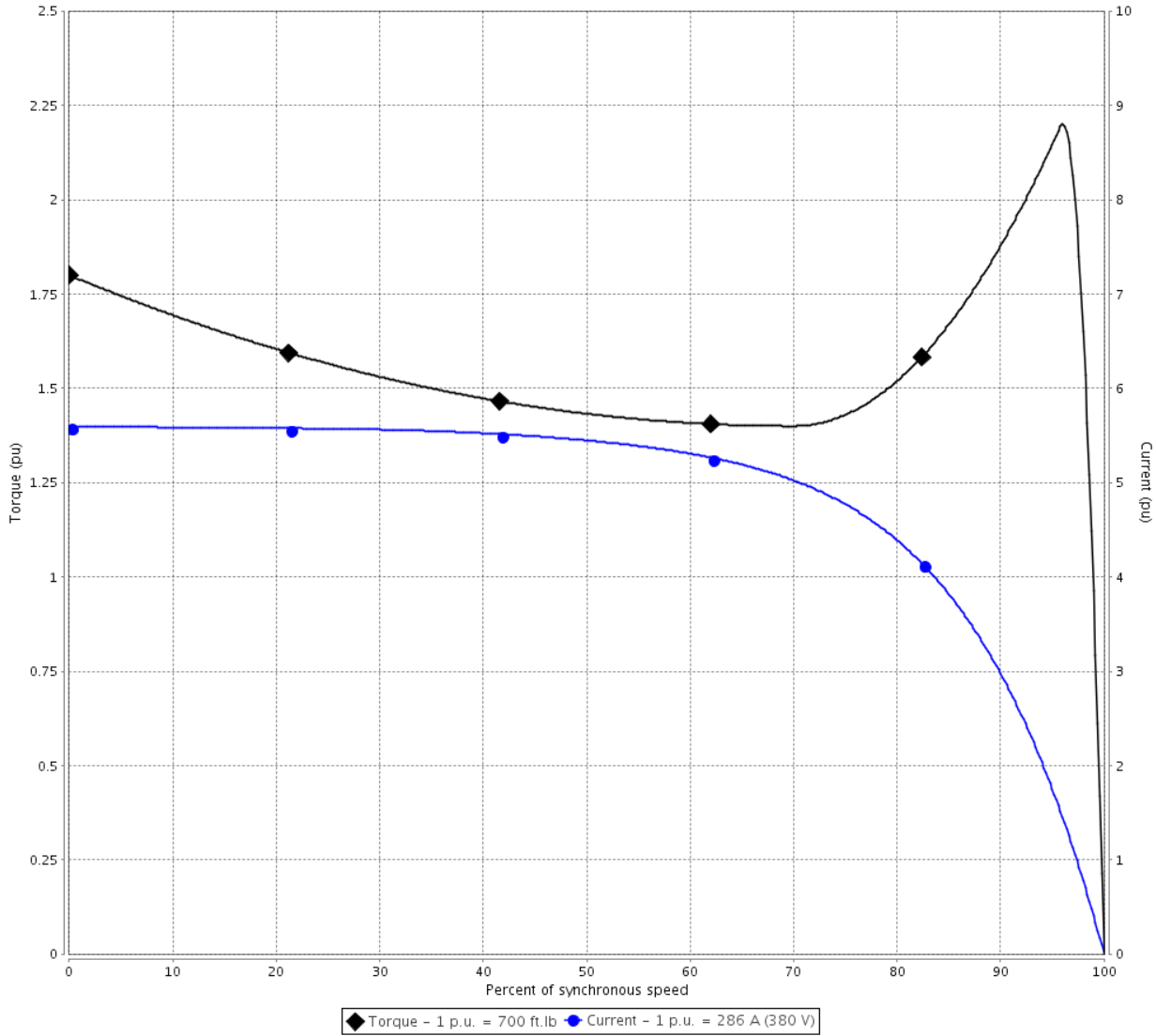

Performance : 380 V 50 Hz 4P

Rated current	: 286 A	Moment of inertia (J)	: 49.5 sq.ft.lb
LRC	: 5.6	Duty cycle	: Cont.(S1)
Rated torque	: 700 ft.lb	Insulation class	: F
Locked rotor torque	: 180 %	Service factor	: 1.15
Breakdown torque	: 220 %	Temperature rise	: 80 K
Rated speed	: 1480 rpm	Design	: B

Locked rotor time : 23s (cold) 13s (hot)

Rev.	Changes Summary	Performed	Checked	Date
Performed by			Page 6 / 36	Revision
Checked by				
Date	06/11/2019			

# TORQUE AND CURRENT VS SPEED CURVE



## Three Phase Induction Motor - Squirrel Cage

Customer :

Product line : ODP NEMA Premium Efficiency  
Three-Phase

Product code : 10869627

Catalog # : 20018OT3G445T

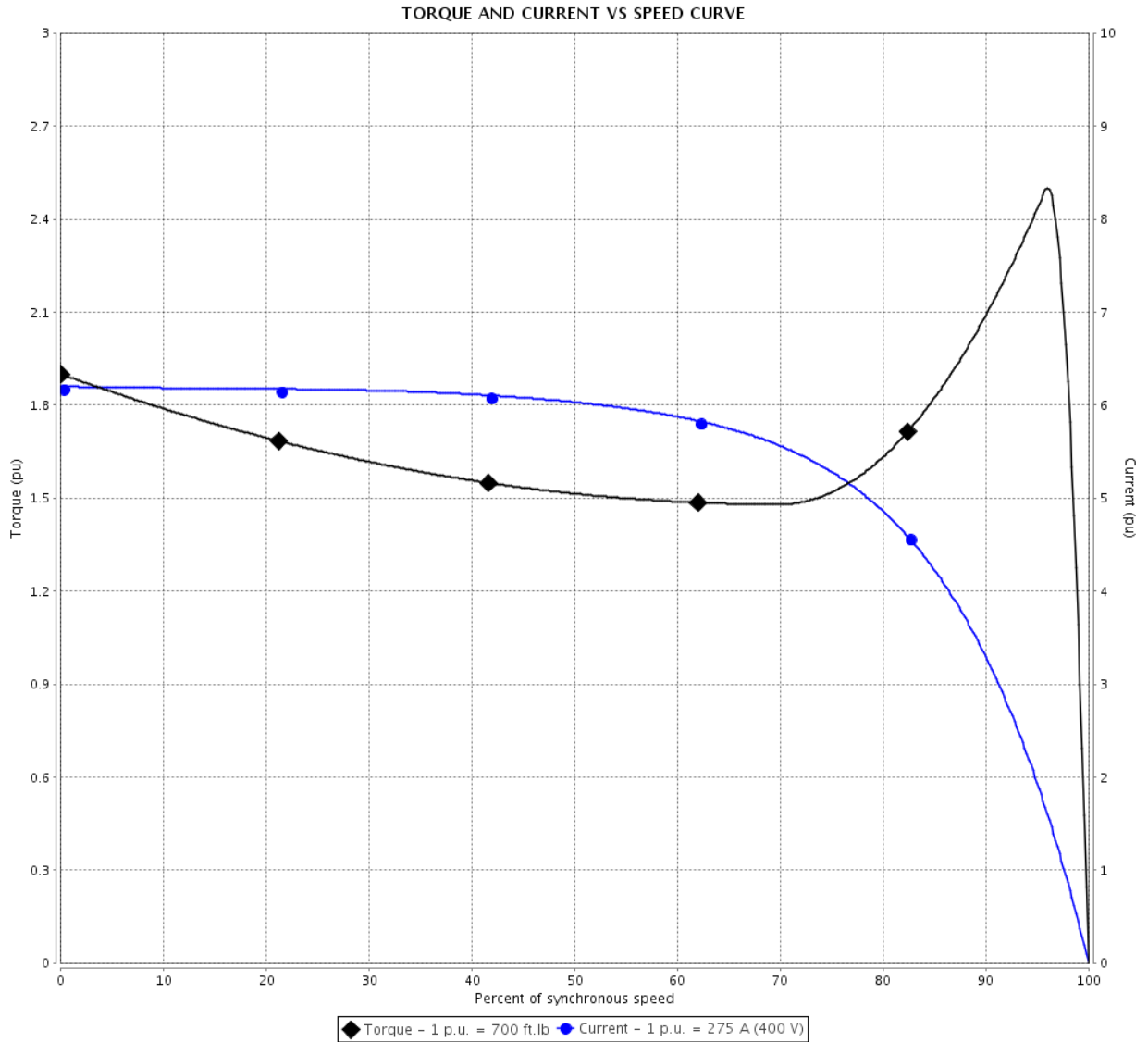

Performance : 400 V 50 Hz 4P

Rated current	: 275 A	Moment of inertia (J)	: 49.5 sq.ft.lb
LRC	: 6.2	Duty cycle	: Cont.(S1)
Rated torque	: 700 ft.lb	Insulation class	: F
Locked rotor torque	: 190 %	Service factor	: 1.15
Breakdown torque	: 250 %	Temperature rise	: 80 K
Rated speed	: 1480 rpm	Design	: B

Locked rotor time : 21s (cold) 12s (hot)

Rev.	Changes Summary	Performed	Checked	Date
Performed by			Page 7 / 36	Revision
Checked by				
Date	06/11/2019			

# TORQUE AND CURRENT VS SPEED CURVE

## Three Phase Induction Motor - Squirrel Cage



Customer :

Product line : ODP NEMA Premium Efficiency  
Three-Phase

Product code : 10869627

Catalog # : 20018OT3G445T

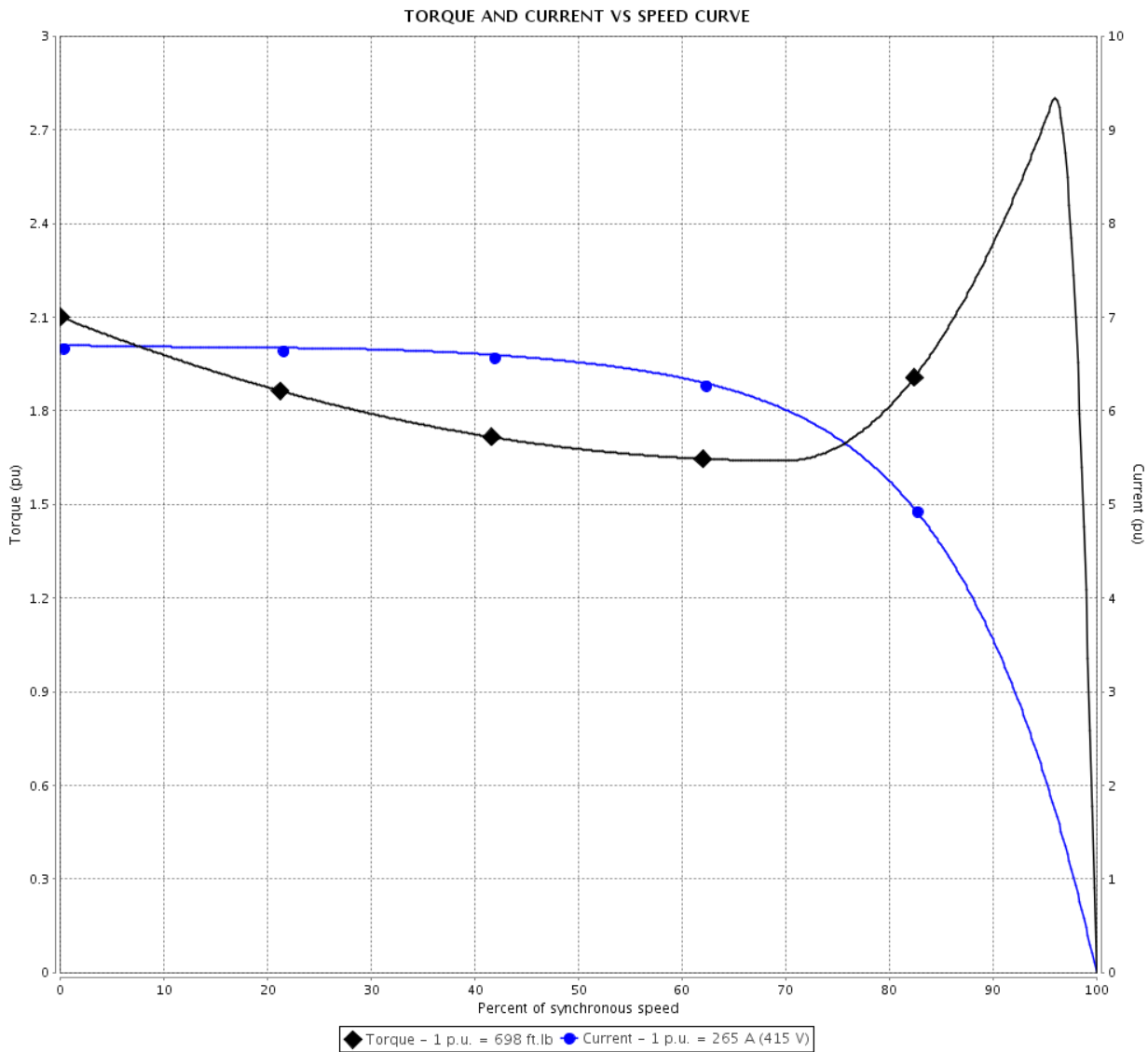

Performance : 415 V 50 Hz 4P IE2

Rated current	: 265 A	Moment of inertia (J)	: 49.5 sq.ft.lb
LRC	: 6.7	Duty cycle	: Cont.(S1)
Rated torque	: 698 ft.lb	Insulation class	: F
Locked rotor torque	: 210 %	Service factor	: 1.15
Breakdown torque	: 280 %	Temperature rise	: 80 K
Rated speed	: 1485 rpm	Design	: B

Locked rotor time : 19s (cold) 11s (hot)

Rev.	Changes Summary	Performed	Checked	Date
Performed by			Page 8 / 36	Revision
Checked by				
Date	06/11/2019			

# LOAD PERFORMANCE CURVE

## Three Phase Induction Motor - Squirrel Cage



Customer :

Product line : ODP NEMA Premium Efficiency  
Three-Phase

Product code : 10869627

Catalog # : 20018OT3G445T

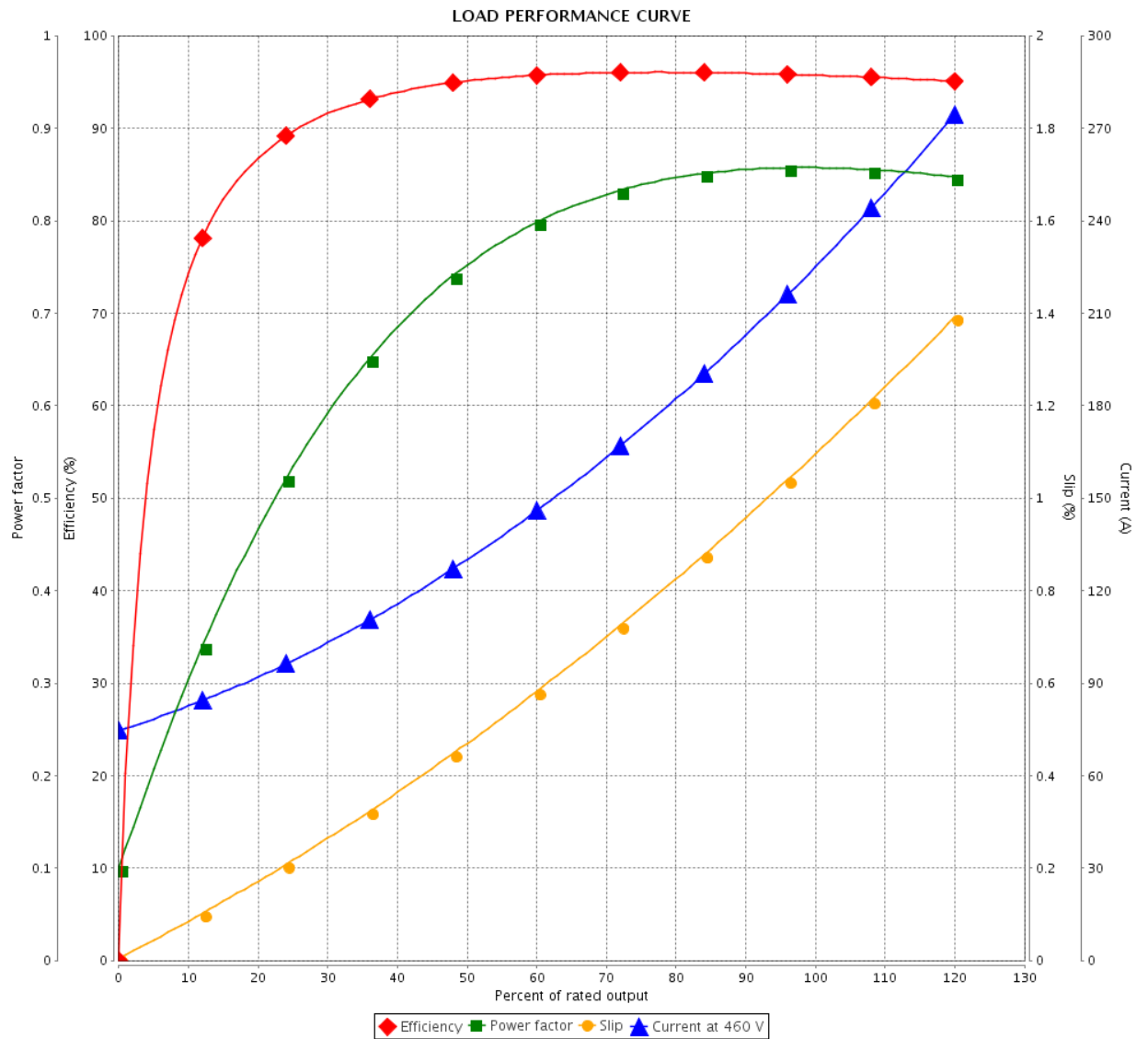

Performance : 460 V 60 Hz 4P

Rated current : 229 A  
 LRC : 6.1  
 Rated torque : 582 ft.lb  
 Locked rotor torque : 200 %  
 Breakdown torque : 229 %  
 Rated speed : 1780 rpm

Moment of inertia (J) : 49.5 sq.ft.lb  
 Duty cycle : Cont.(S1)  
 Insulation class : F  
 Service factor : 1.15  
 Temperature rise : 80 K  
 Design : B

Rev.	Changes Summary	Performed	Checked	Date
Performed by		Page		Revision
Checked by		9 / 36		
Date		06/11/2019		

# LOAD PERFORMANCE CURVE

Three Phase Induction Motor - Squirrel Cage



Customer :

Product line : ODP NEMA Premium Efficiency Three-Phase

Product code : 10869627

Catalog # : 20018OT3G445T

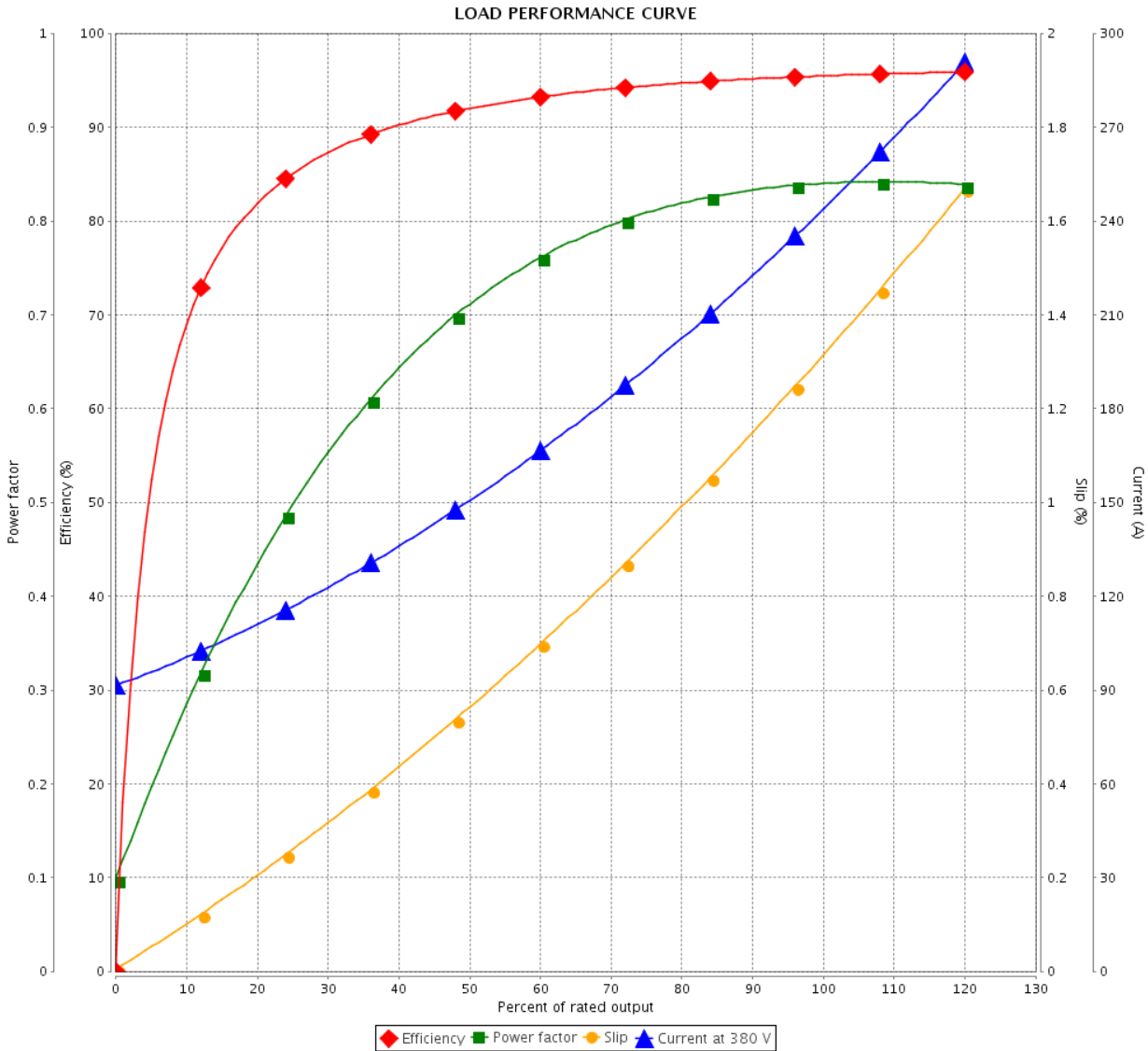

Performance : 380 V 50 Hz 4P IE3

Rated current : 250 A  
 LRC : 6.3  
 Rated torque : 613 ft.lb  
 Locked rotor torque : 210 %  
 Breakdown torque : 250 %  
 Rated speed : 1480 rpm

Moment of inertia (J) : 49.5 sq.ft.lb  
 Duty cycle : Cont.(S1)  
 Insulation class : F  
 Service factor : 1.15  
 Temperature rise : 80 K  
 Design : B

Rev.	Changes Summary	Performed	Checked	Date
Performed by			Page	Revision
Checked by			10 / 36	
Date	06/11/2019			

# LOAD PERFORMANCE CURVE

## Three Phase Induction Motor - Squirrel Cage



Customer :

Product line : ODP NEMA Premium Efficiency Three-Phase

Product code : 10869627

Catalog # : 20018OT3G445T

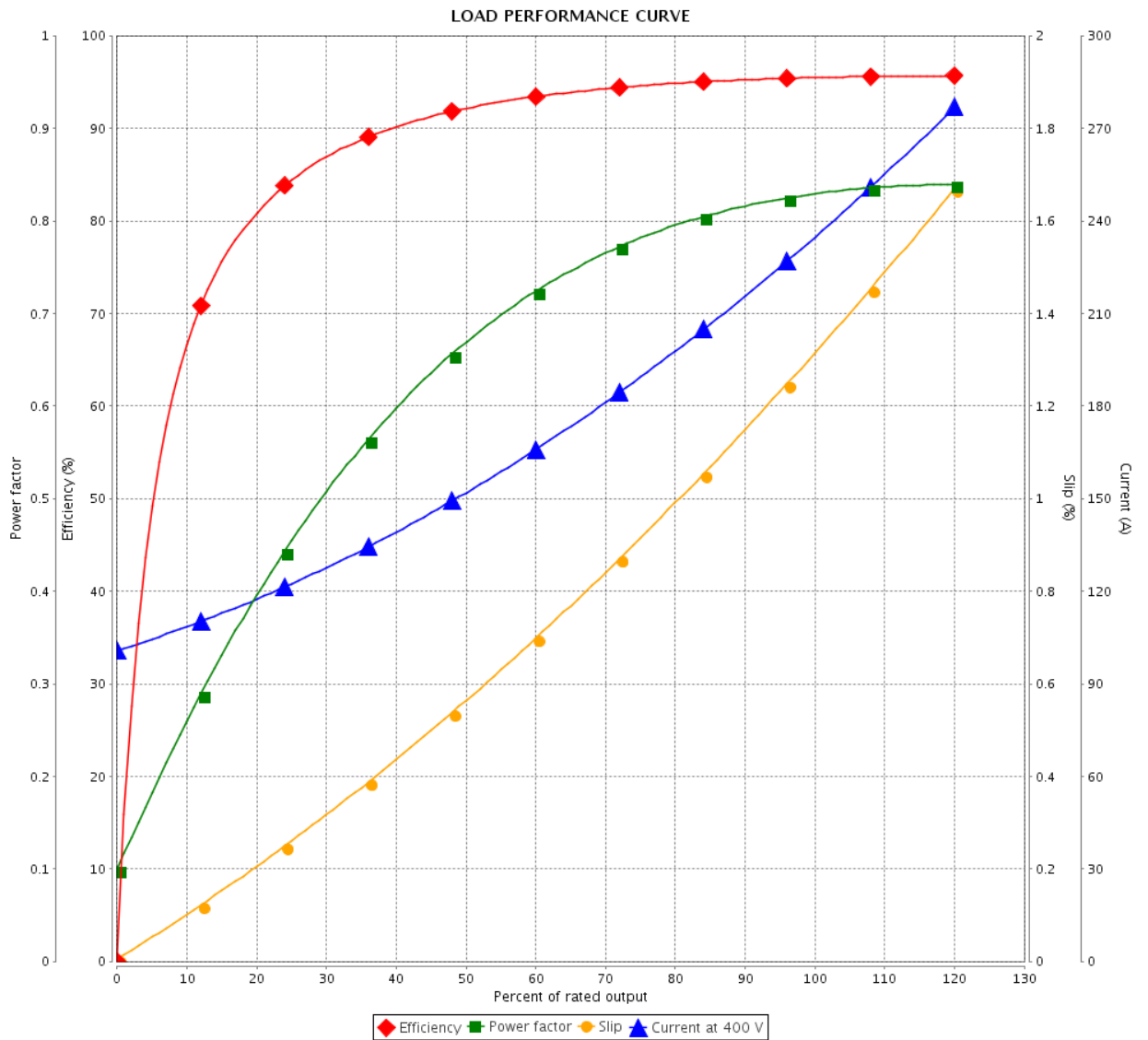

Performance : 400 V 50 Hz 4P IE3

Rated current : 240 A  
 LRC : 7.0  
 Rated torque : 613 ft.lb  
 Locked rotor torque : 220 %  
 Breakdown torque : 290 %  
 Rated speed : 1480 rpm

Moment of inertia (J) : 49.5 sq.ft.lb  
 Duty cycle : Cont.(S1)  
 Insulation class : F  
 Service factor : 1.15  
 Temperature rise : 80 K  
 Design : B

Rev.	Changes Summary	Performed	Checked	Date
Performed by		Page		Revision
Checked by		11 / 36		
Date		06/11/2019		

# LOAD PERFORMANCE CURVE

Three Phase Induction Motor - Squirrel Cage



Customer :

Product line : ODP NEMA Premium Efficiency  
Three-Phase

Product code : 10869627

Catalog # : 20018OT3G445T

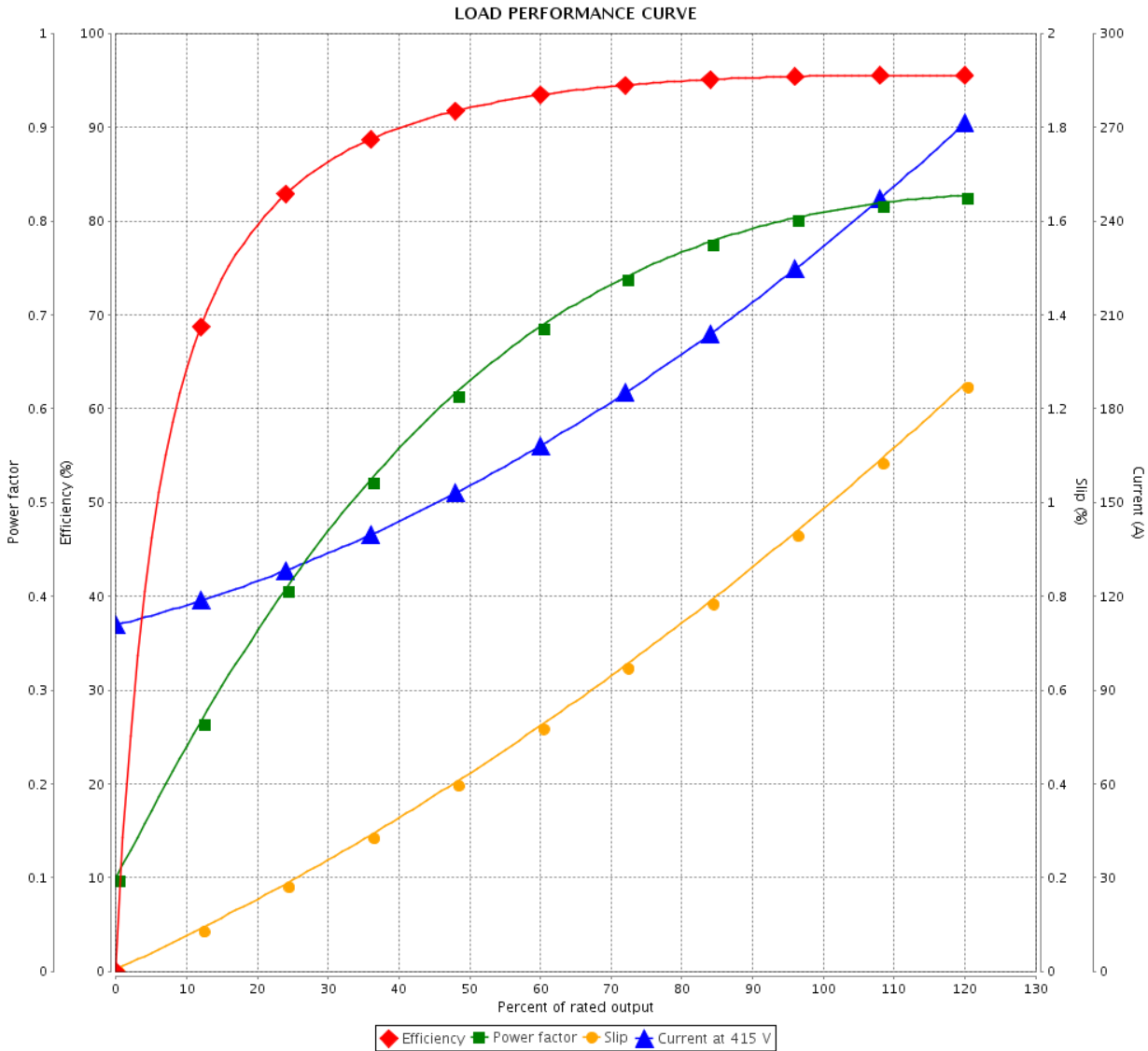

Performance : 415 V 50 Hz 4P IE3

Rated current : 237 A  
 LRC : 7.5  
 Rated torque : 611 ft.lb  
 Locked rotor torque : 240 %  
 Breakdown torque : 320 %  
 Rated speed : 1485 rpm

Moment of inertia (J) : 49.5 sq.ft.lb  
 Duty cycle : Cont.(S1)  
 Insulation class : F  
 Service factor : 1.15  
 Temperature rise : 80 K  
 Design : B

Rev.	Changes Summary	Performed	Checked	Date
Performed by			Page 12 / 36	Revision
Checked by				
Date	06/11/2019			

# LOAD PERFORMANCE CURVE

## Three Phase Induction Motor - Squirrel Cage



Customer :

Product line : ODP NEMA Premium Efficiency  
Three-Phase

Product code : 10869627

Catalog # : 20018OT3G445T

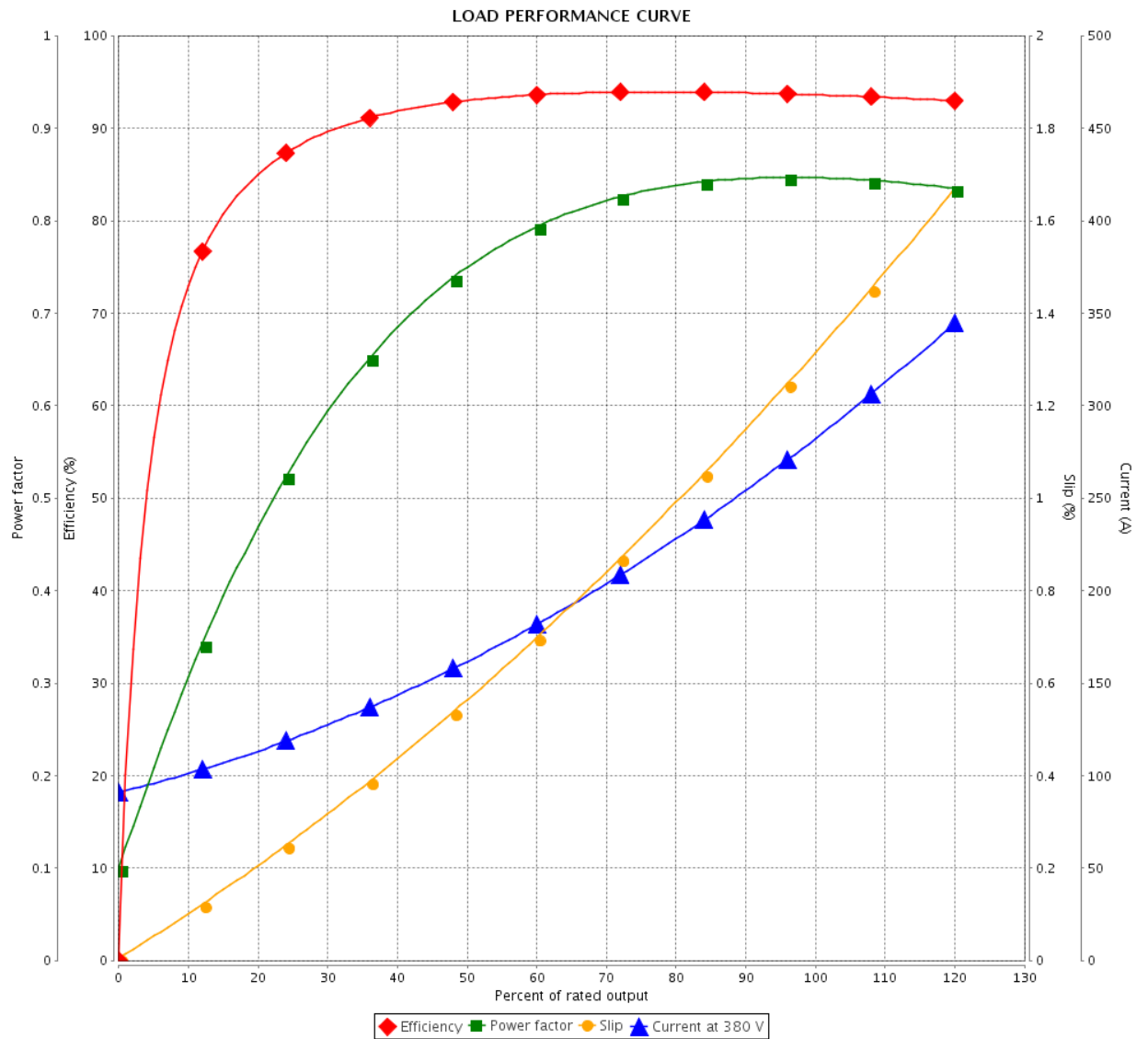

Performance : 380 V 50 Hz 4P

Rated current : 286 A  
 LRC : 5.6  
 Rated torque : 700 ft.lb  
 Locked rotor torque : 180 %  
 Breakdown torque : 220 %  
 Rated speed : 1480 rpm

Moment of inertia (J) : 49.5 sq.ft.lb  
 Duty cycle : Cont.(S1)  
 Insulation class : F  
 Service factor : 1.15  
 Temperature rise : 80 K  
 Design : B

Rev.	Changes Summary	Performed	Checked	Date
Performed by		Page		Revision
Checked by		13 / 36		
Date		06/11/2019		

# LOAD PERFORMANCE CURVE

Three Phase Induction Motor - Squirrel Cage



Customer : \_\_\_\_\_

Product line : ODP NEMA Premium Efficiency  
Three-Phase

Product code : 10869627

Catalog # : 20018OT3G445T

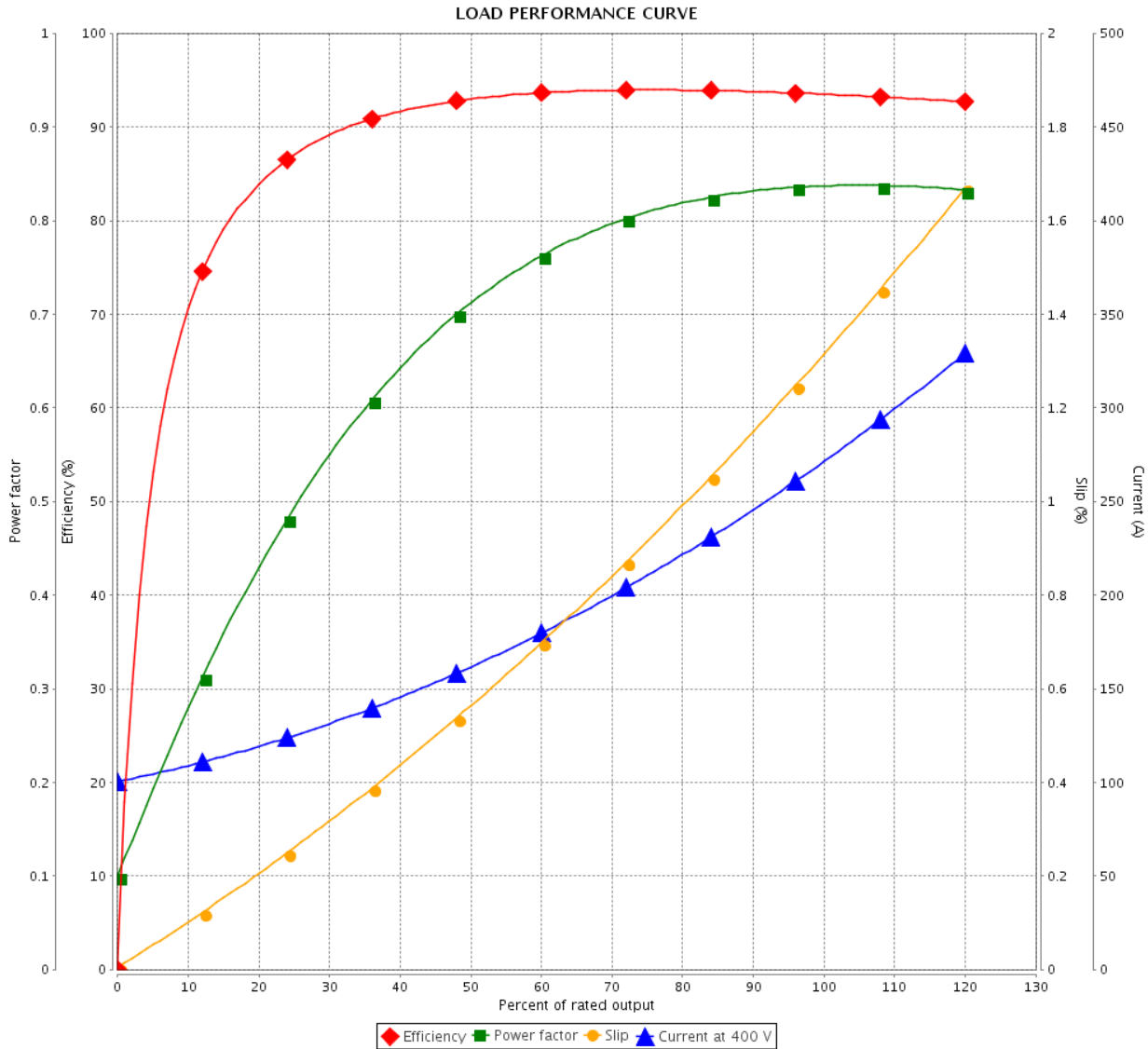

Performance : 400 V 50 Hz 4P

Rated current : 275 A	Moment of inertia (J) : 49.5 sq.ft.lb
LRC : 6.2	Duty cycle : Cont.(S1)
Rated torque : 700 ft.lb	Insulation class : F
Locked rotor torque : 190 %	Service factor : 1.15
Breakdown torque : 250 %	Temperature rise : 80 K
Rated speed : 1480 rpm	Design : B

Rev.	Changes Summary	Performed	Checked	Date
Performed by			Page 14 / 36	Revision
Checked by				
Date	06/11/2019			

# LOAD PERFORMANCE CURVE

## Three Phase Induction Motor - Squirrel Cage



Customer :

Product line : ODP NEMA Premium Efficiency Three-Phase

Product code : 10869627

Catalog # : 20018OT3G445T

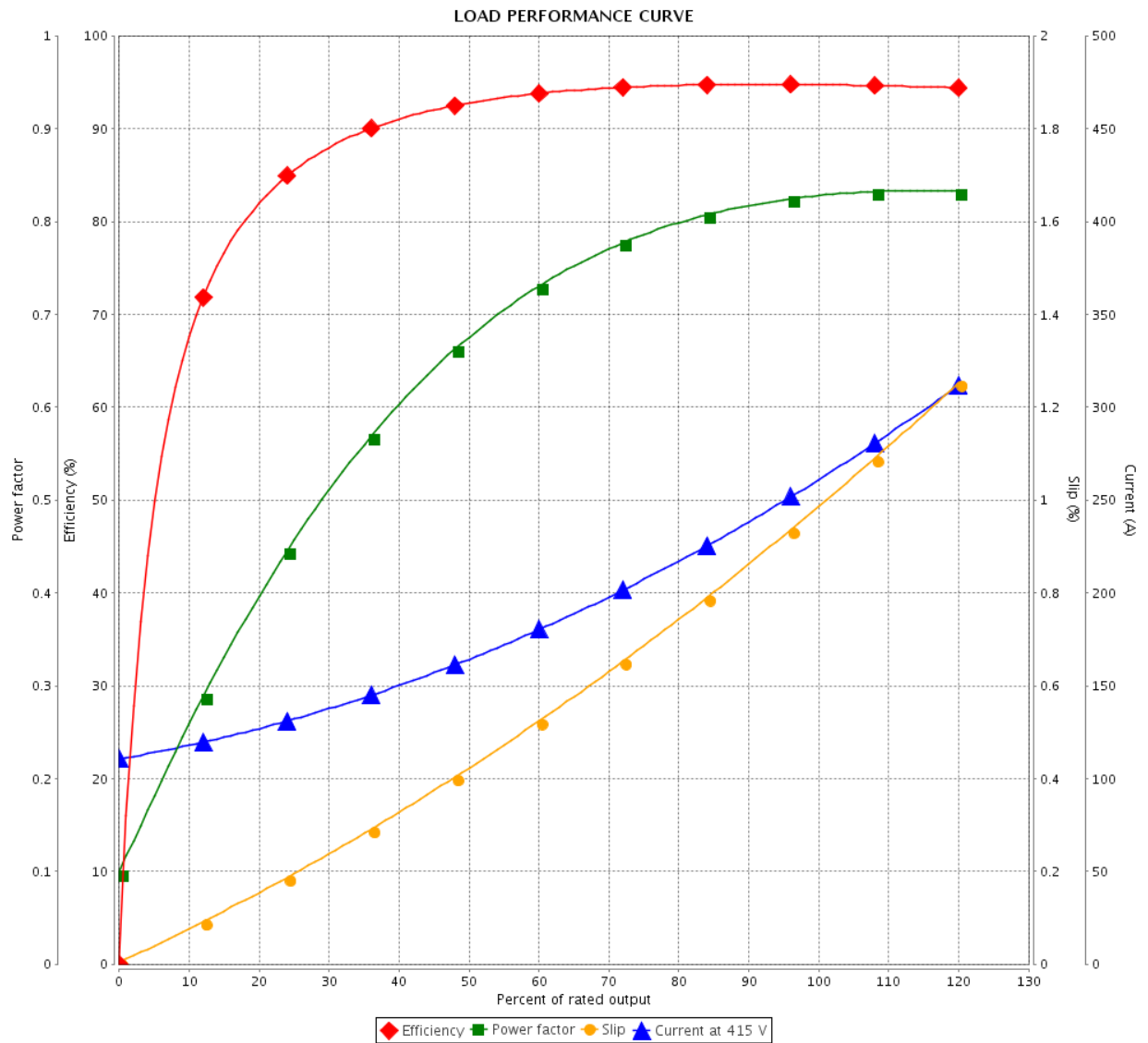

Performance : 415 V 50 Hz 4P IE2

Rated current : 265 A  
 LRC : 6.7  
 Rated torque : 698 ft.lb  
 Locked rotor torque : 210 %  
 Breakdown torque : 280 %  
 Rated speed : 1485 rpm

Moment of inertia (J) : 49.5 sq.ft.lb  
 Duty cycle : Cont.(S1)  
 Insulation class : F  
 Service factor : 1.15  
 Temperature rise : 80 K  
 Design : B

Rev.	Changes Summary	Performed	Checked	Date
Performed by		Page		Revision
Checked by		15 / 36		
Date		06/11/2019		

# THERMAL LIMIT CURVE

Three Phase Induction Motor - Squirrel Cage



Customer : \_\_\_\_\_

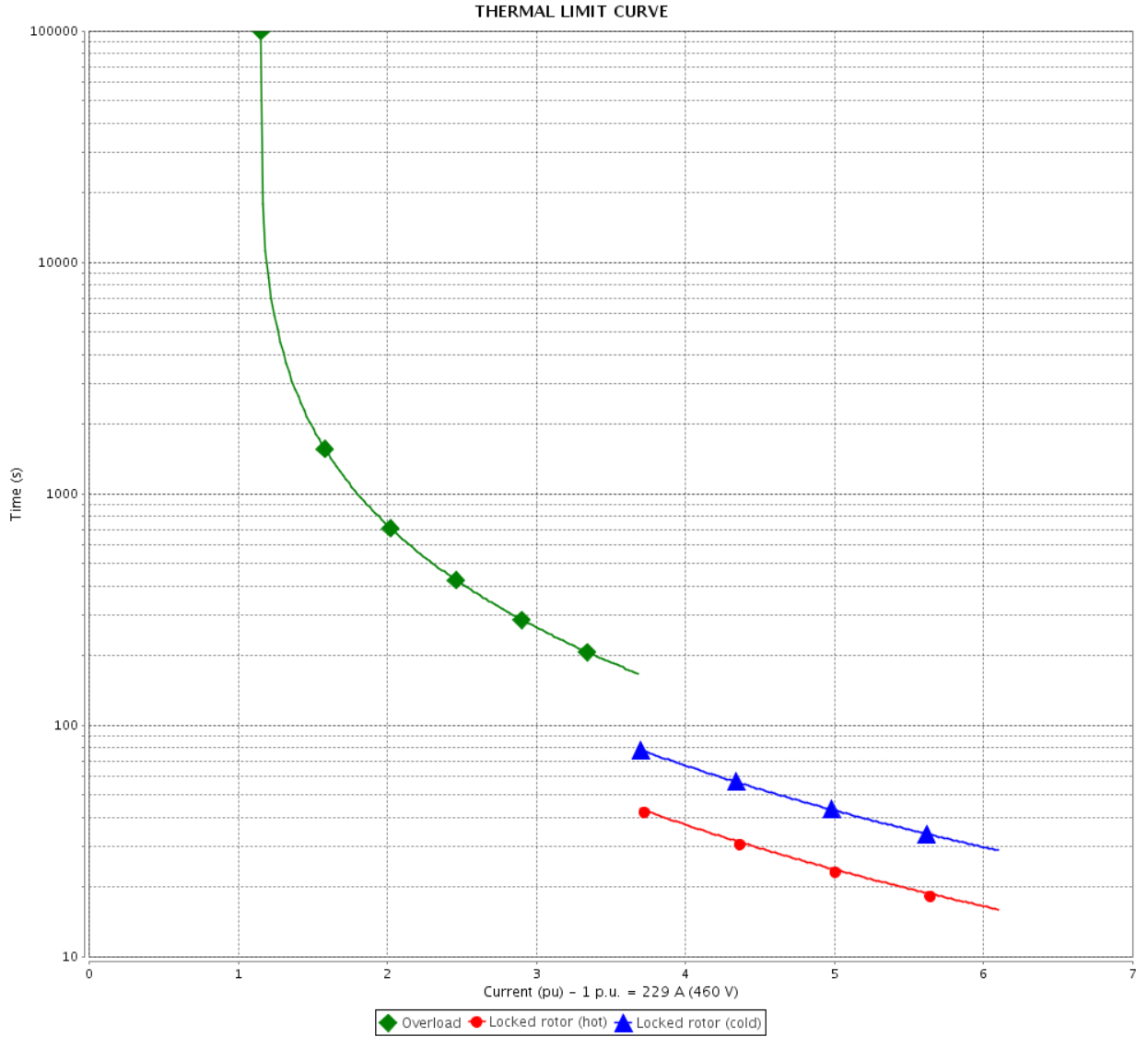

Rev.	Changes Summary	Performed	Checked	Date
Performed by		Page      Revision 17 / 36		
Checked by				
Date				

# THERMAL LIMIT CURVE

Three Phase Induction Motor - Squirrel Cage



Customer : \_\_\_\_\_

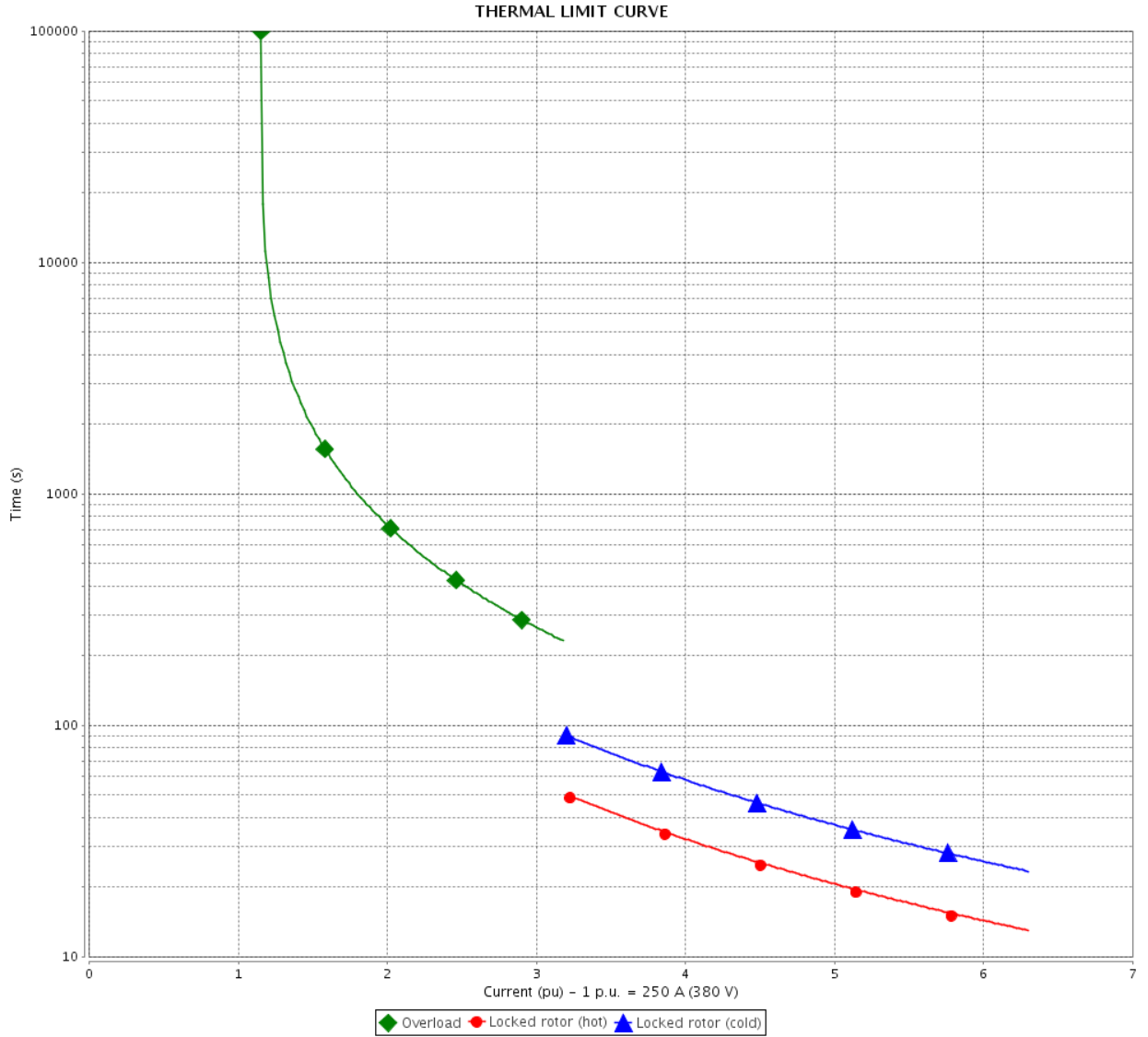

Rev.	Changes Summary	Performed	Checked	Date
Performed by		Page      Revision 19 / 36		
Checked by				
Date				

# THERMAL LIMIT CURVE

Three Phase Induction Motor - Squirrel Cage



Customer : \_\_\_\_\_

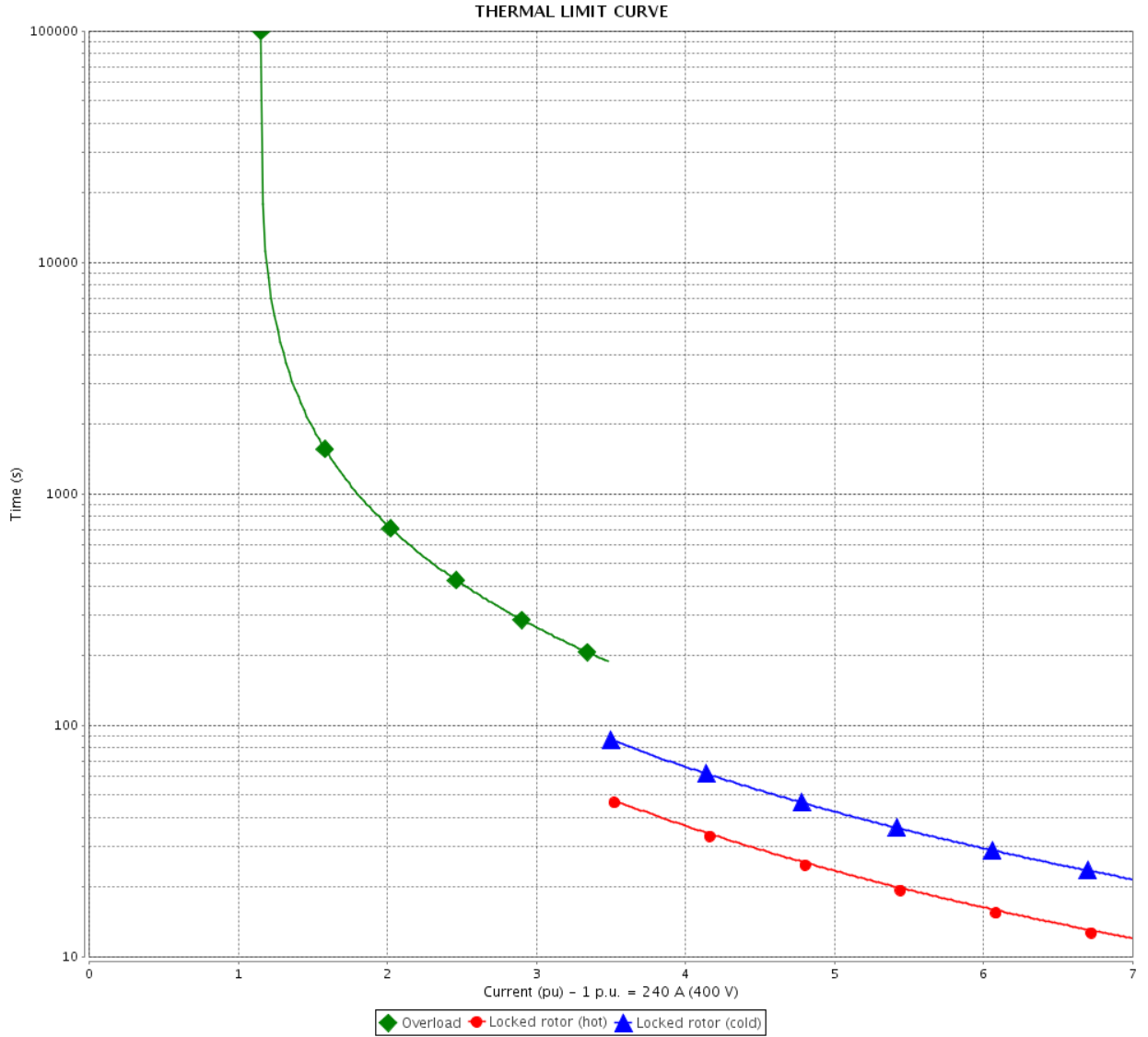

Rev.	Changes Summary	Performed	Checked	Date
Performed by		Page 21 / 36      Revision		
Checked by				
Date				

# THERMAL LIMIT CURVE

Three Phase Induction Motor - Squirrel Cage



Customer : \_\_\_\_\_

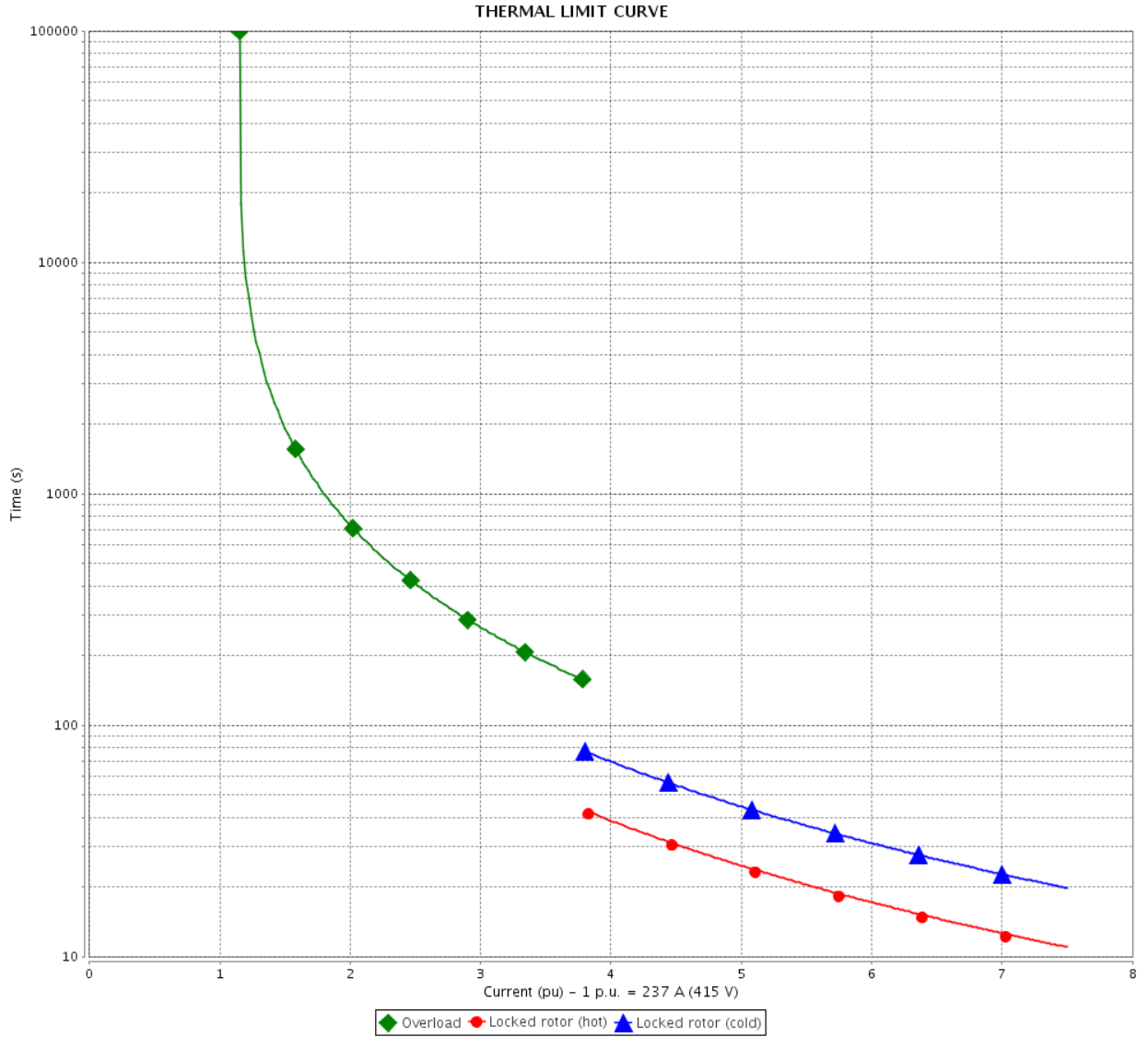

Rev.	Changes Summary	Performed	Checked	Date
Performed by			Page	Revision
Checked by				
Date				
			23 / 36	

# THERMAL LIMIT CURVE

Three Phase Induction Motor - Squirrel Cage

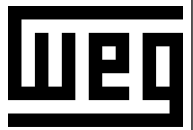

Customer : \_\_\_\_\_

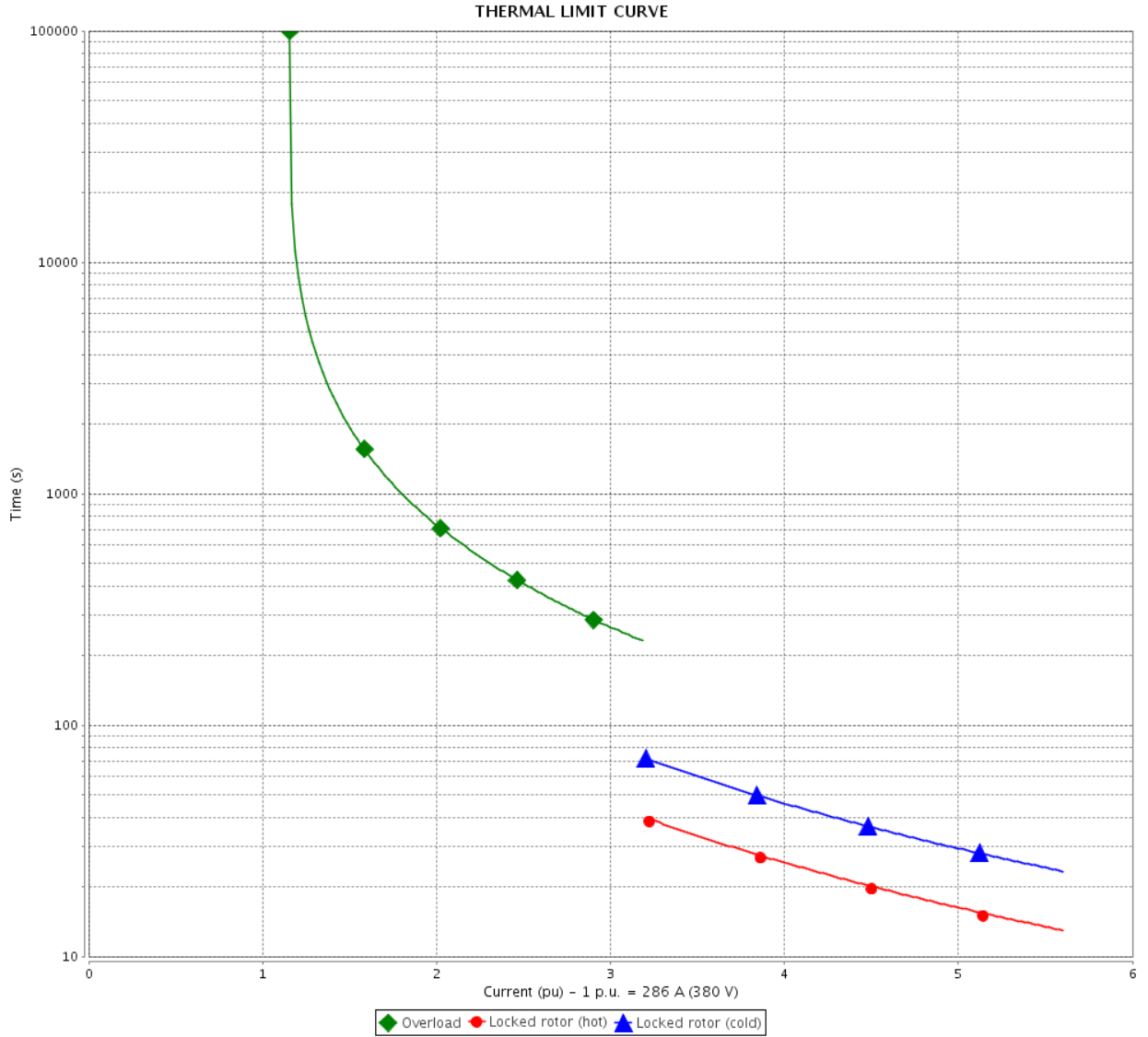

Rev.	Changes Summary	Performed	Checked	Date
Performed by				
Checked by				
Date				
			Page	Revision
			25 / 36	

# THERMAL LIMIT CURVE

Three Phase Induction Motor - Squirrel Cage



Customer : \_\_\_\_\_

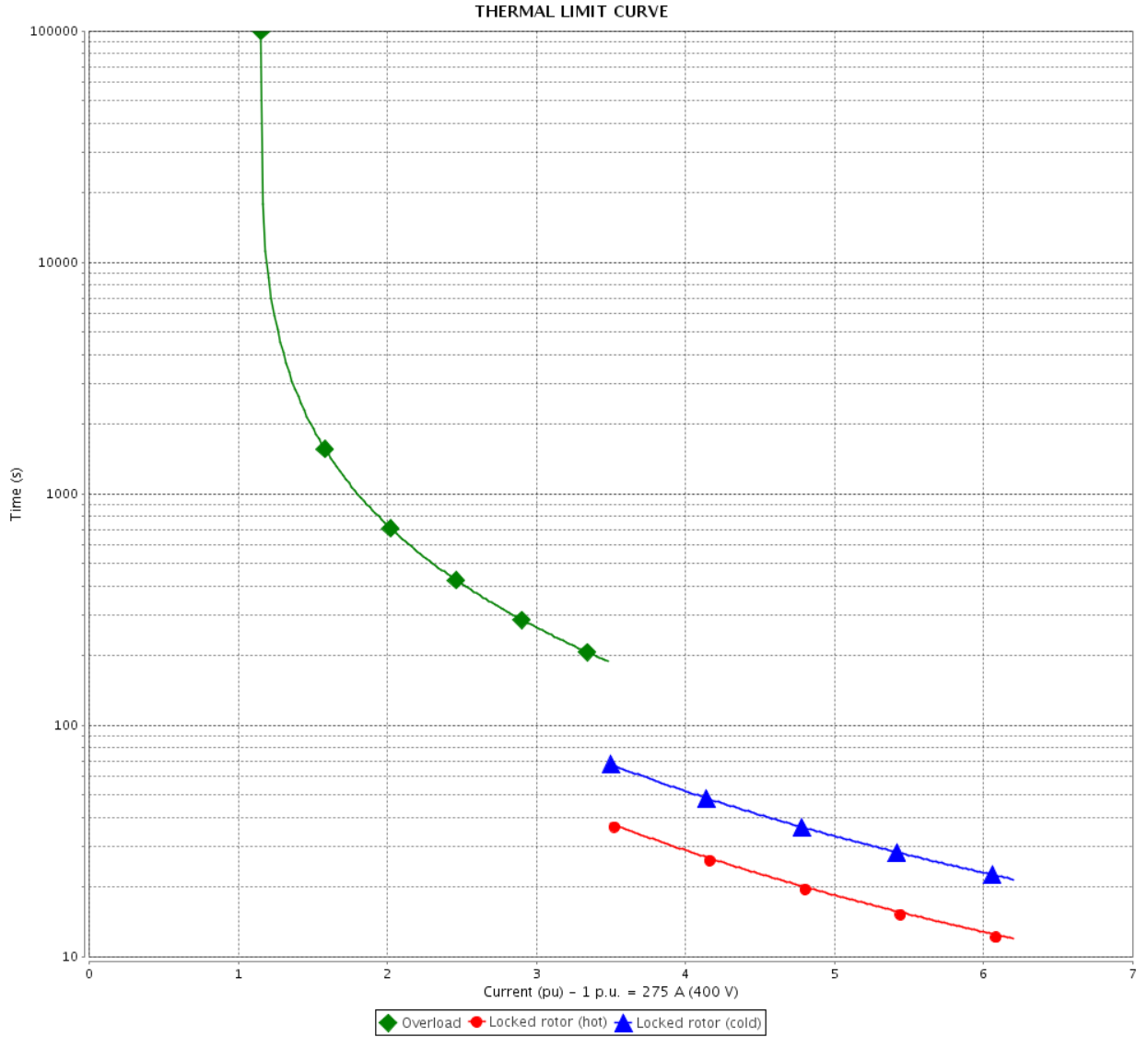

Rev.	Changes Summary	Performed	Checked	Date
Performed by		Page 27 / 36		Revision
Checked by				
Date				

# THERMAL LIMIT CURVE

Three Phase Induction Motor - Squirrel Cage



Customer : \_\_\_\_\_

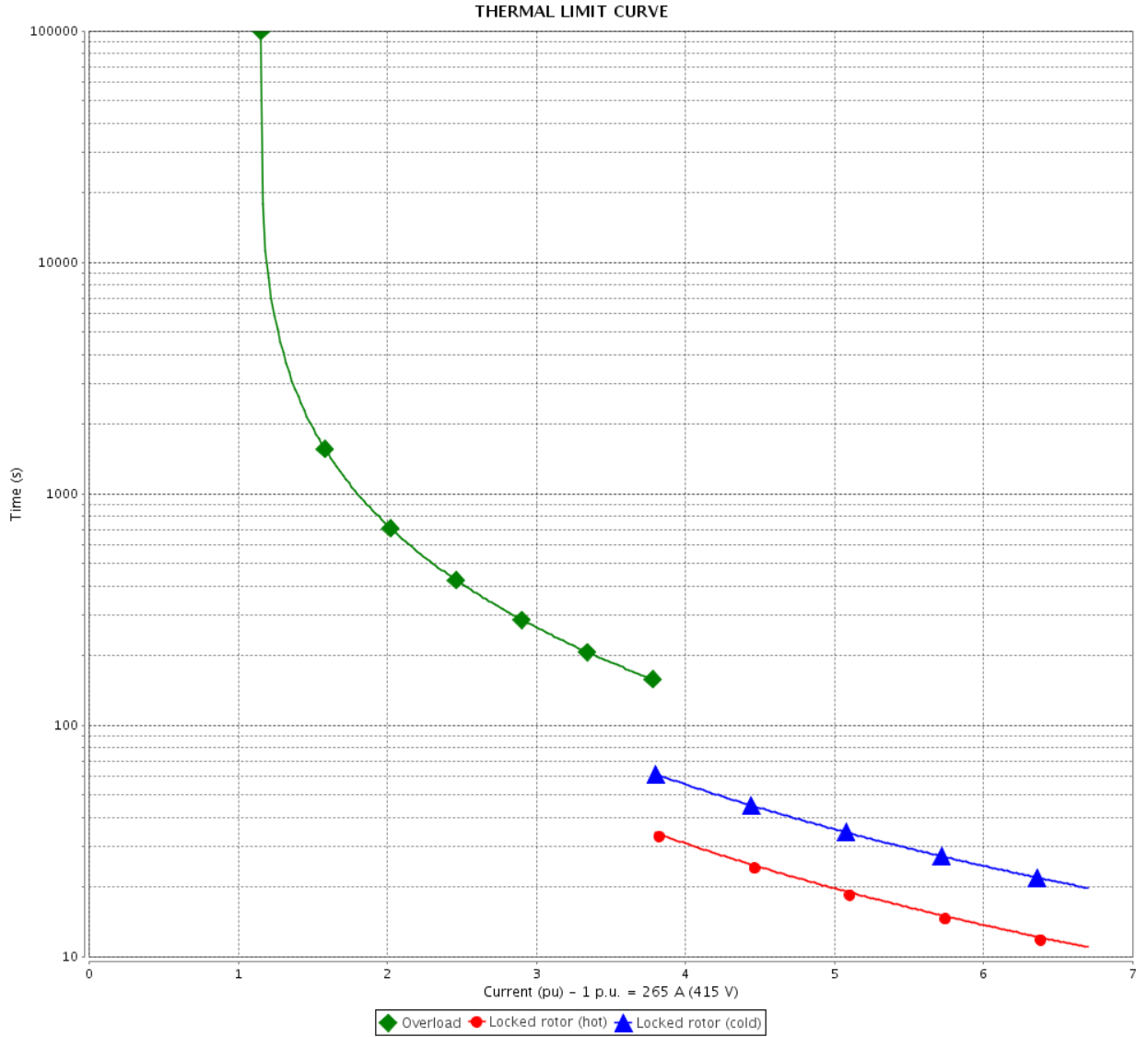

Rev.	Changes Summary	Performed	Checked	Date
Performed by		Page 29 / 36		Revision
Checked by				
Date				

# VFD OPERATION CURVE

Three Phase Induction Motor - Squirrel Cage



Customer :

Product line : ODP NEMA Premium Efficiency Three-Phase

Product code : 10869627

Catalog # : 20018OT3G445T

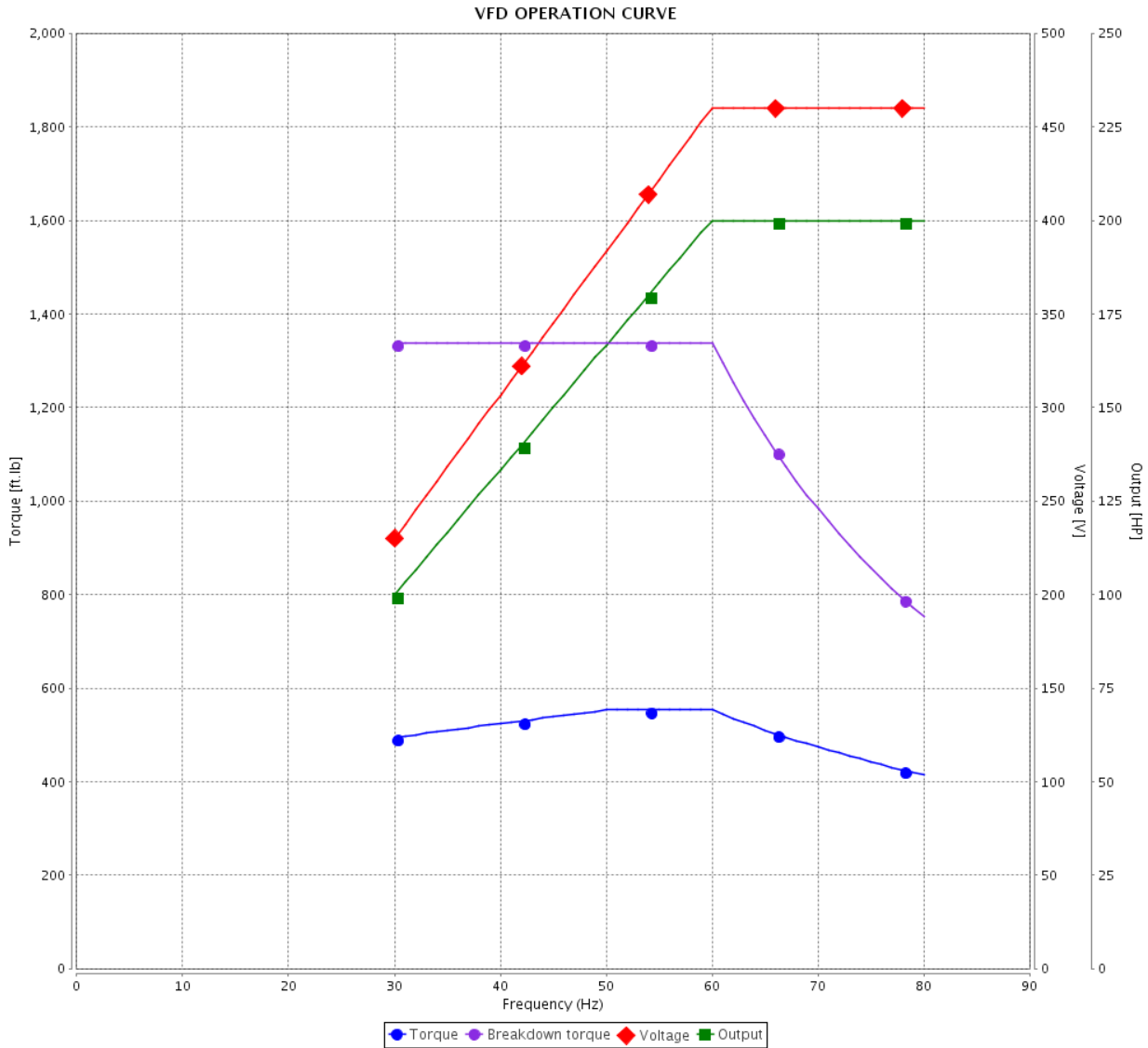

Performance : 460 V 60 Hz 4P

Rated current	: 229 A	Moment of inertia (J)	: 49.5 sq.ft.lb
LRC	: 6.1	Duty cycle	: Cont.(S1)
Rated torque	: 582 ft.lb	Insulation class	: F
Locked rotor torque	: 200 %	Service factor	: 1.15
Breakdown torque	: 229 %	Temperature rise	: 80 K
Rated speed	: 1780 rpm	Design	: B

Rev.	Changes Summary	Performed	Checked	Date
Performed by			Page 30 / 36	Revision
Checked by				
Date	06/11/2019			

# VFD OPERATION CURVE

Three Phase Induction Motor - Squirrel Cage



Customer :

Product line : ODP NEMA Premium Efficiency  
Three-Phase

Product code : 10869627

Catalog # : 20018OT3G445T

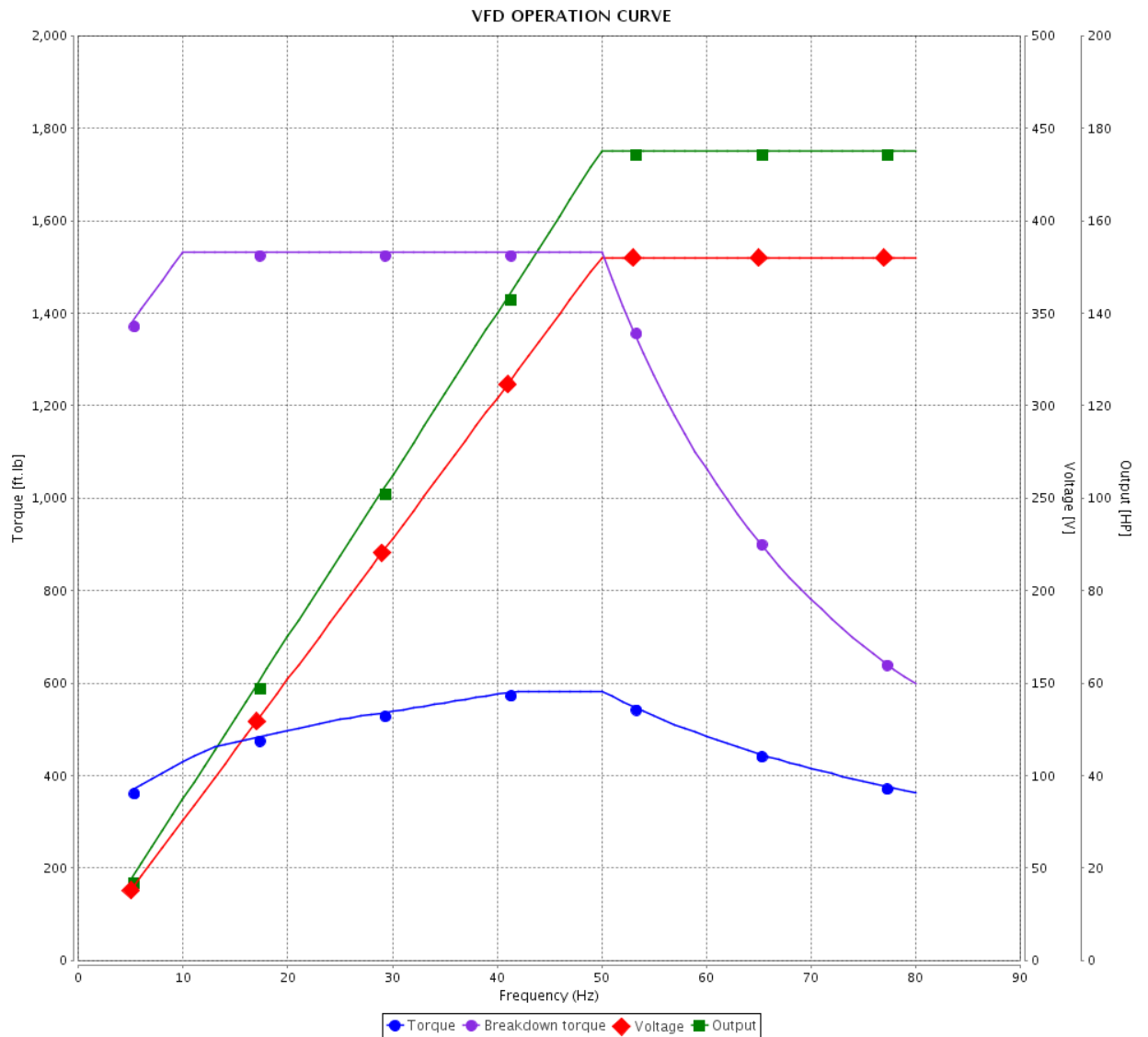

Performance : 380 V 50 Hz 4P IE3

Rated current : 250 A  
LRC : 6.3  
Rated torque : 613 ft.lb  
Locked rotor torque : 210 %  
Breakdown torque : 250 %  
Rated speed : 1480 rpm

Moment of inertia (J) : 49.5 sq.ft.lb  
Duty cycle : Cont.(S1)  
Insulation class : F  
Service factor : 1.15  
Temperature rise : 80 K  
Design : B

Rev.	Changes Summary	Performed	Checked	Date
Performed by		Page		Revision
Checked by		31 / 36		
Date	06/11/2019			

# VFD OPERATION CURVE

Three Phase Induction Motor - Squirrel Cage



Customer :

Product line : ODP NEMA Premium Efficiency  
Three-Phase

Product code : 10869627

Catalog # : 20018OT3G445T

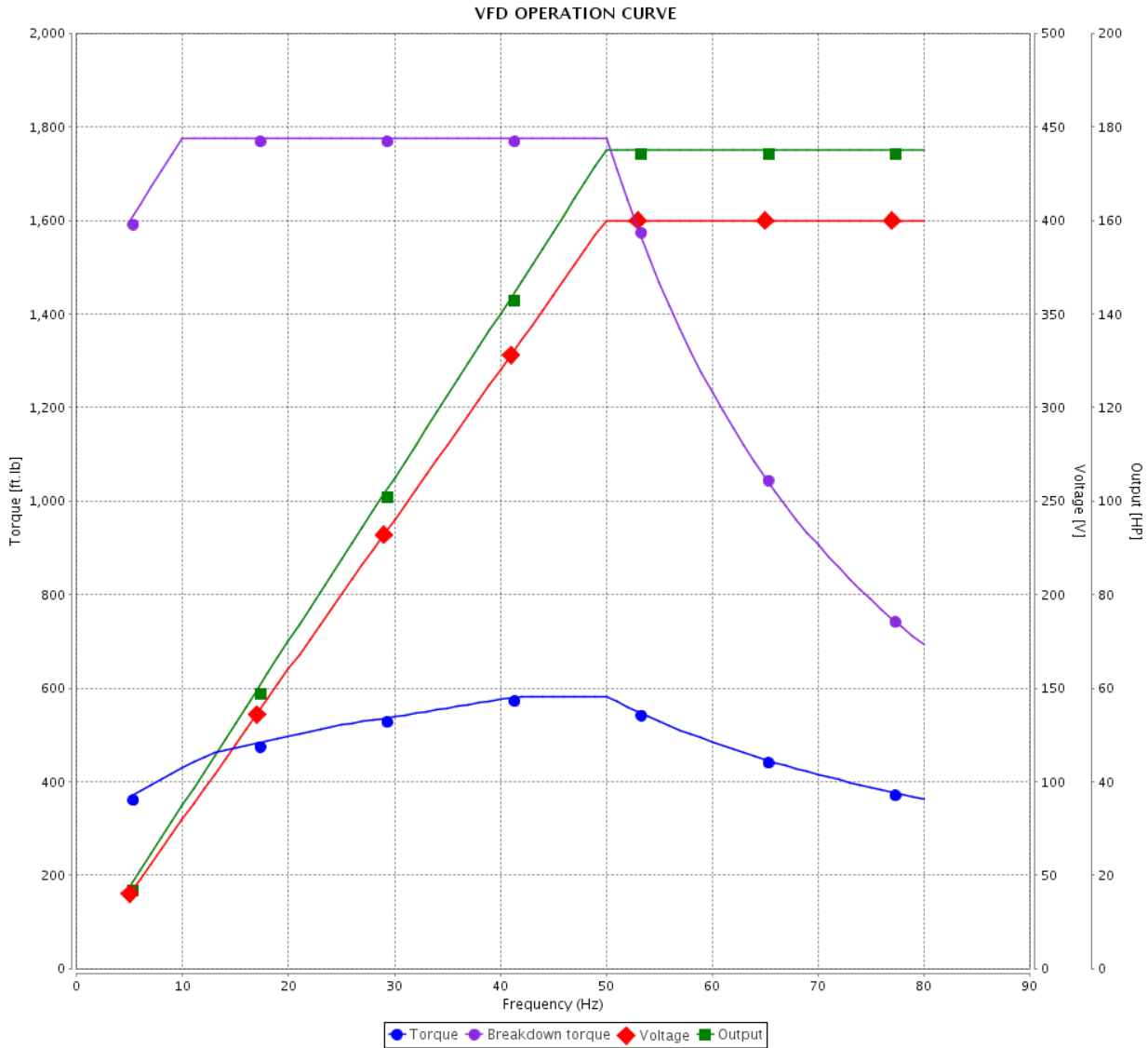

Performance : 400 V 50 Hz 4P IE3

Rated current	: 240 A	Moment of inertia (J)	: 49.5 sq.ft.lb
LRC	: 7.0	Duty cycle	: Cont.(S1)
Rated torque	: 613 ft.lb	Insulation class	: F
Locked rotor torque	: 220 %	Service factor	: 1.15
Breakdown torque	: 290 %	Temperature rise	: 80 K
Rated speed	: 1480 rpm	Design	: B

Rev.	Changes Summary	Performed	Checked	Date
Performed by			Page 32 / 36	Revision
Checked by				
Date	06/11/2019			

# VFD OPERATION CURVE

Three Phase Induction Motor - Squirrel Cage



Customer :

Product line : ODP NEMA Premium Efficiency  
Three-Phase

Product code : 10869627

Catalog # : 20018OT3G445T

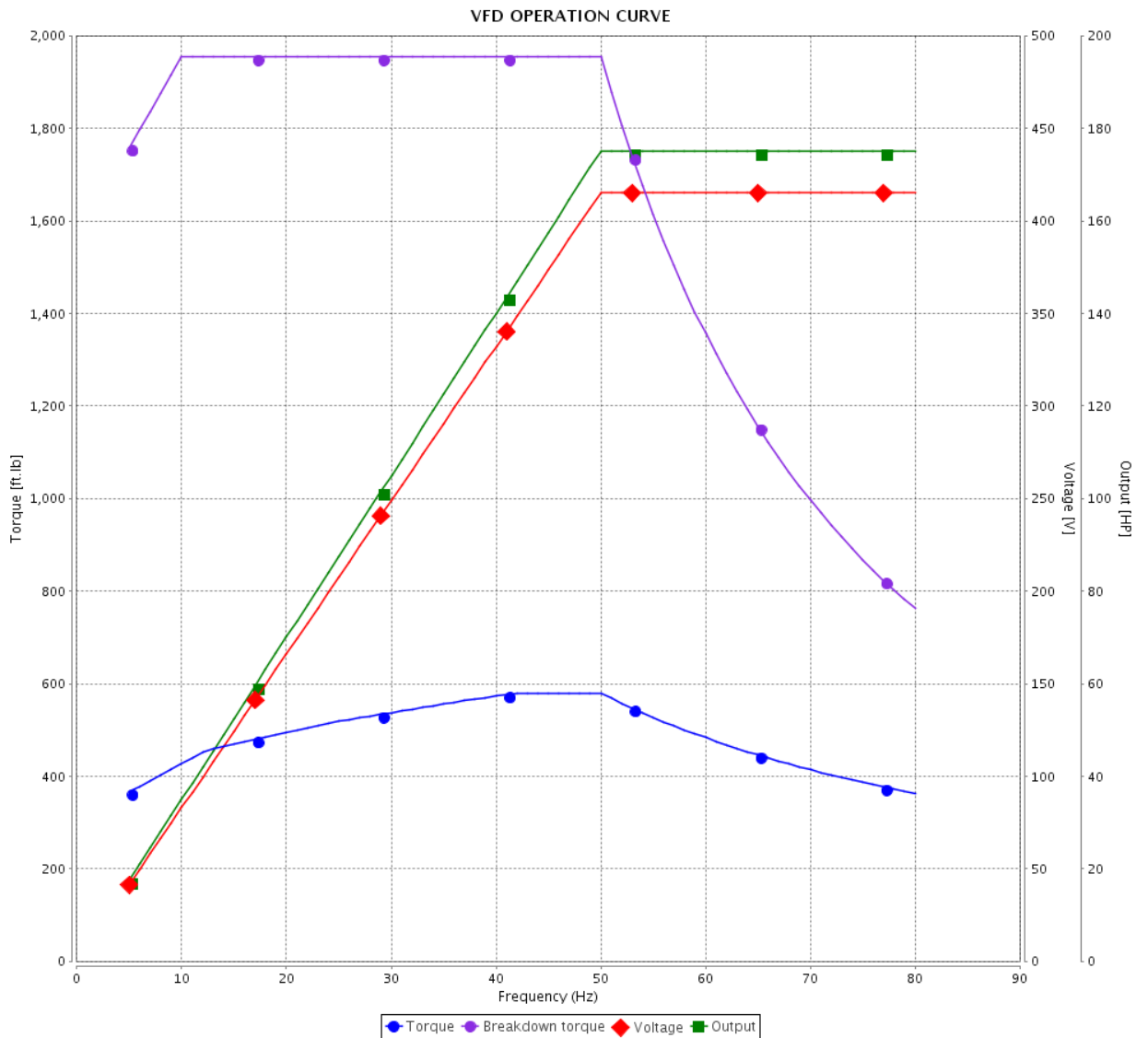

Performance : 415 V 50 Hz 4P IE3

Rated current : 237 A  
LRC : 7.5  
Rated torque : 611 ft.lb  
Locked rotor torque : 240 %  
Breakdown torque : 320 %  
Rated speed : 1485 rpm

Moment of inertia (J) : 49.5 sq.ft.lb  
Duty cycle : Cont.(S1)  
Insulation class : F  
Service factor : 1.15  
Temperature rise : 80 K  
Design : B

Rev.	Changes Summary	Performed	Checked	Date
Performed by		Page		Revision
Checked by		33 / 36		
Date	06/11/2019			

# VFD OPERATION CURVE

Three Phase Induction Motor - Squirrel Cage



Customer :

Product line : ODP NEMA Premium Efficiency  
Three-Phase

Product code : 10869627

Catalog # : 20018OT3G445T

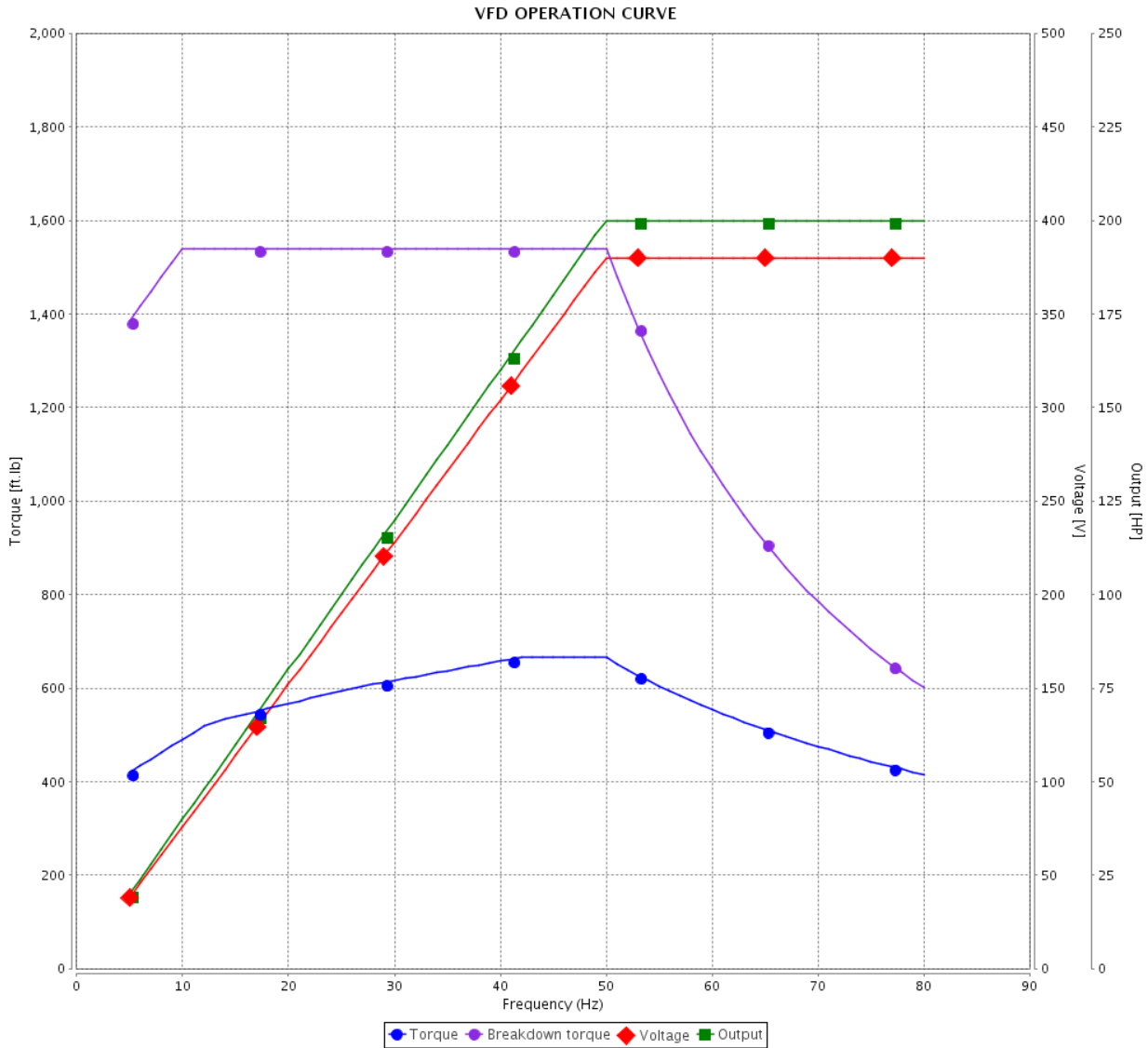

Performance : 380 V 50 Hz 4P

Rated current	: 286 A	Moment of inertia (J)	: 49.5 sq.ft.lb
LRC	: 5.6	Duty cycle	: Cont.(S1)
Rated torque	: 700 ft.lb	Insulation class	: F
Locked rotor torque	: 180 %	Service factor	: 1.15
Breakdown torque	: 220 %	Temperature rise	: 80 K
Rated speed	: 1480 rpm	Design	: B

Rev.	Changes Summary	Performed	Checked	Date
Performed by			Page 34 / 36	Revision
Checked by				
Date	06/11/2019			

# VFD OPERATION CURVE

## Three Phase Induction Motor - Squirrel Cage



Customer : \_\_\_\_\_

Product line : ODP NEMA Premium Efficiency  
Three-Phase

Product code : 10869627

Catalog # : 20018OT3G445T

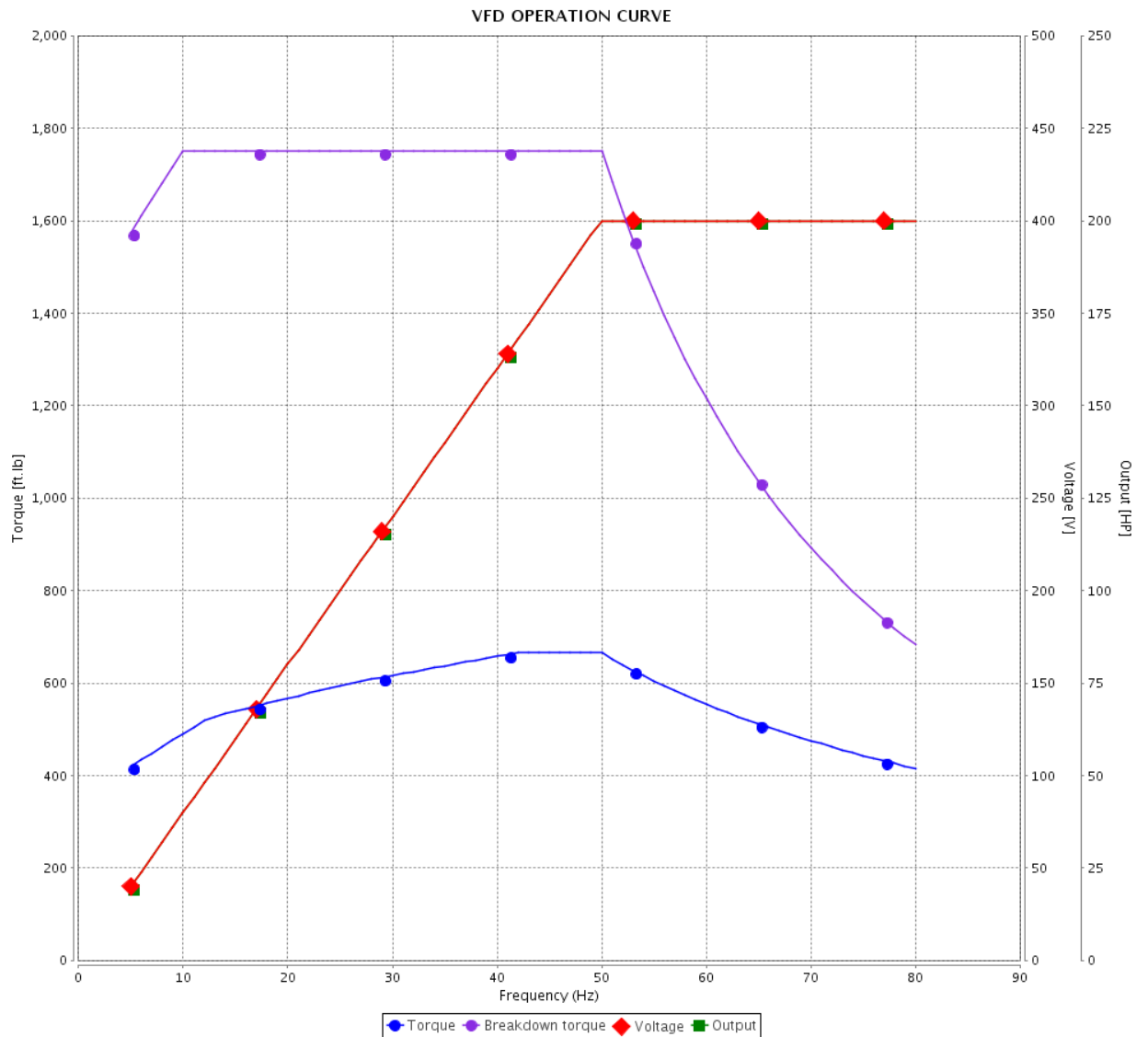

Performance : 400 V 50 Hz 4P

Rated current : 275 A  
LRC : 6.2  
Rated torque : 700 ft.lb  
Locked rotor torque : 190 %  
Breakdown torque : 250 %  
Rated speed : 1480 rpm

Moment of inertia (J) : 49.5 sq.ft.lb  
Duty cycle : Cont.(S1)  
Insulation class : F  
Service factor : 1.15  
Temperature rise : 80 K  
Design : B

Rev.	Changes Summary	Performed	Checked	Date
Performed by		Page		Revision
Checked by		35 / 36		
Date	06/11/2019			

# VFD OPERATION CURVE

Three Phase Induction Motor - Squirrel Cage



Customer :

Product line : ODP NEMA Premium Efficiency  
Three-Phase

Product code : 10869627

Catalog # : 20018OT3G445T

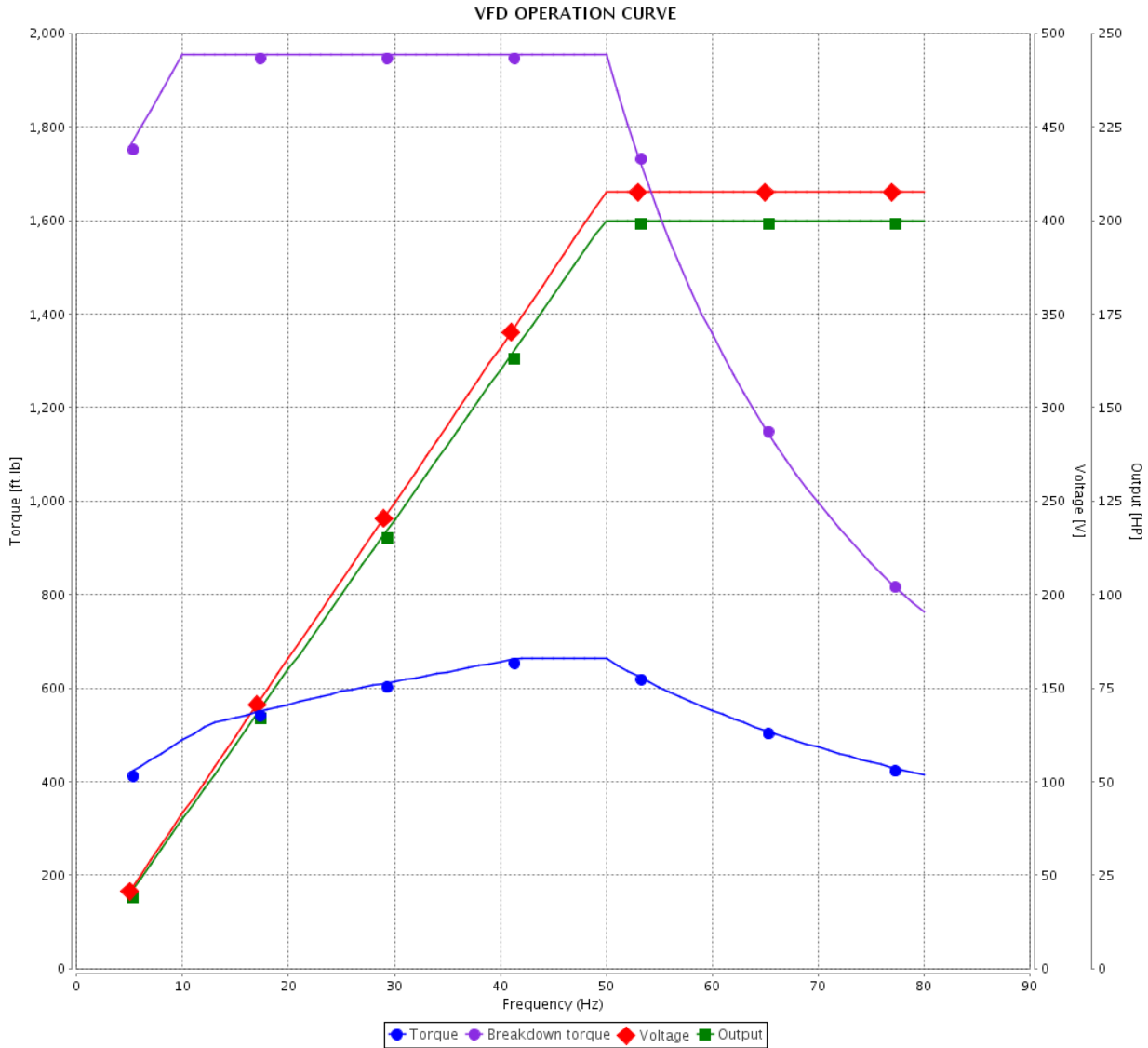

Performance : 415 V 50 Hz 4P IE2

Rated current	: 265 A	Moment of inertia (J)	: 49.5 sq.ft.lb
LRC	: 6.7	Duty cycle	: Cont.(S1)
Rated torque	: 698 ft.lb	Insulation class	: F
Locked rotor torque	: 210 %	Service factor	: 1.15
Breakdown torque	: 280 %	Temperature rise	: 80 K
Rated speed	: 1485 rpm	Design	: B

Rev.	Changes Summary	Performed	Checked	Date
Performed by			Page 36 / 36	Revision
Checked by				
Date	06/11/2019			

Dimensões em polegada  
Dimensions in inches

THIS IS AN UPDATED REVISION, THE  
PREVIOUS ONE MUST BE DISREGARDED.

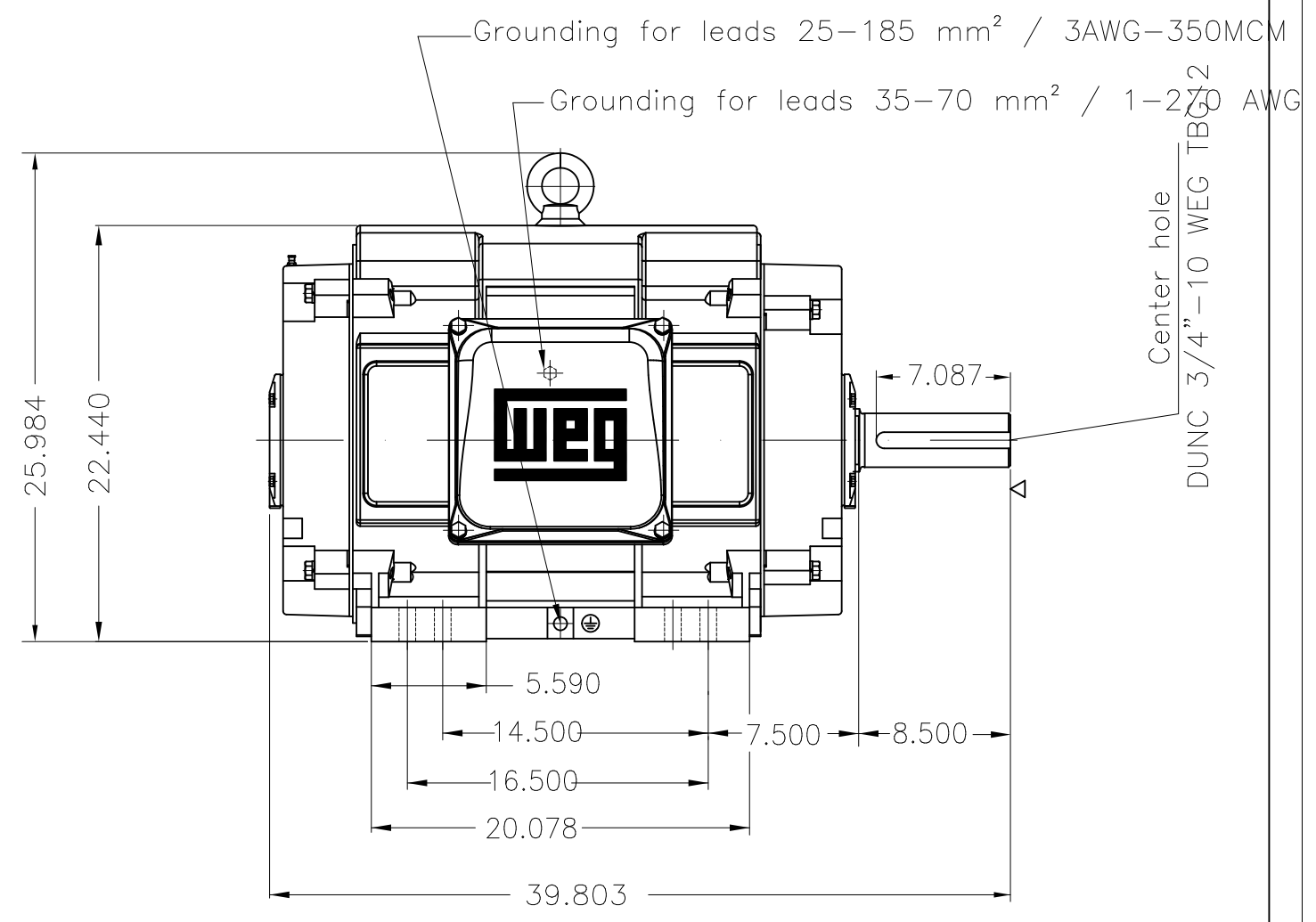
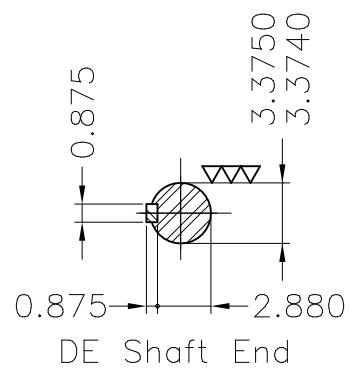
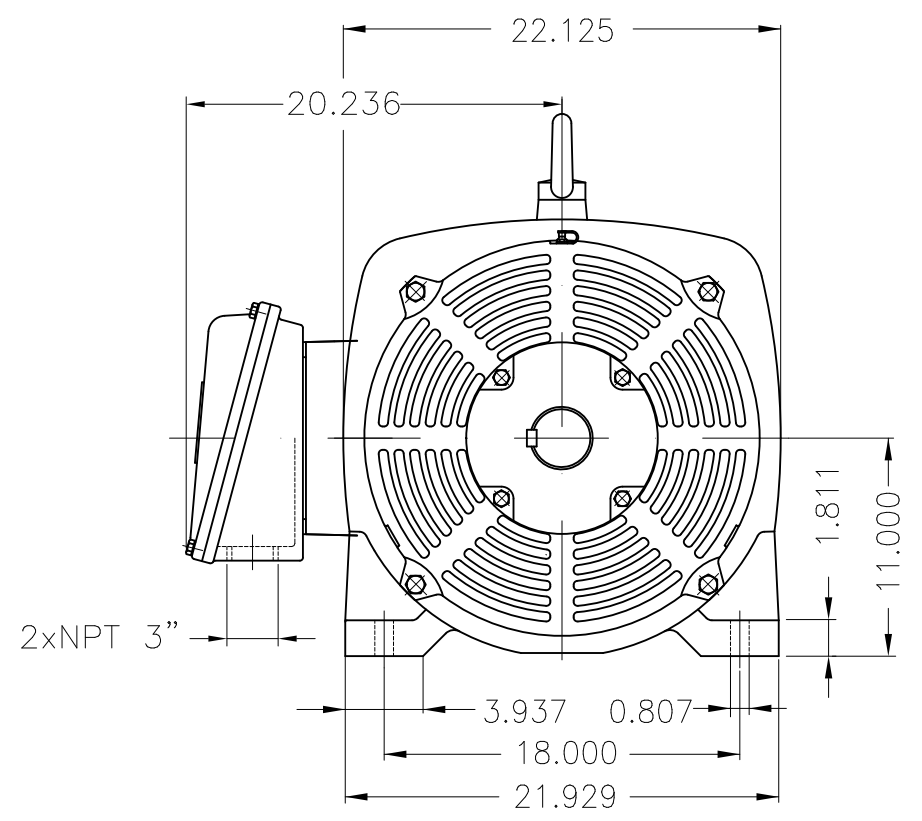

Color RAL 5009  
Painting plan 203A  
Mounting B3R(D)

ECM	LOC	SUMMARY OF MODIFICATIONS	EXECUTED	CHECKED	RELEASED	DATE	VER
EXECUTED	USERADMIN	THREE PHASE NEMA P. EFF MOTOR					
CHECKED		FRAME 444/5T IP23 ODP					
RELEASED		WEG code: 10869627					
REL DT	06.11.2019	WMO Jaragua do Sul	Product Engineering	SHEET	1 / 1		

200 HP 04 Poles 60Hz

A

