

# **BALDOR® • RELIANCE**

**Product Information Packet**

**ELECTRIC MOTOR WHOLESAL.COM**

**GPP7460**

**G.M. D24KA 90VDC 50:1 50 RPM GPP7460**

Part Detail							
Revision:	Q	Status:	PRD/A	Change #:		Proprietary:	No
Type:	DC	Prod. Type:		Elec. Spec:	24WGZ017	CD Diagram:	
Enclosure:	TENV	Mfg Plant:		Mech. Spec:		Layout:	
Frame:	PSL	Mounting:		Poles:	///	Created Date:	03-10-2006
Base:		Rotation:	R	Insulation:	F	Eff. Date:	07-19-2012
Field Type:		Literature:		Elec. Diagram:		Replaced By:	

Nameplate NP1220A08			
CAT.NO.	GPP7460		
SER.NO			
SPEC.	24A614Z017G7		
FRAME	PSL	TYPE	2424P
HP	.25	TE	
VOLTS	90		
AMP	2.5		
F.F.	1.3	CLASS	F
AMB.	40	DUTY	CONT
BRUSHES	2/BP5052BP01		
R.P.M.	50		
TORQ/IN LB	250		
RATIO	50:1		
APRV-CE		APRV-CUL	

Parts List		
Part Number	Description	Quantity
SA140077	SA 24A614Z017G7	1.000 EA
AA011959	AA 24A614Z017G7	1.000 EA
LC0899A08	CONNECTION LABEL, DCPM CCW ROTATION CE C	1.000 EA
BP5052BP01SP	BRUSH, GRADE R884 NATIONAL CARBON (FOR 1	1.000 EA
HG0076A02BL	HSG,PSL EP 24DC FRAME LONG HOUSING	1.000 EA
HW4600D28	SEAL,10X20X4MM TCM #03907815PSCW	1.000 EA
BMH1716	WASHER,PREC 1.175"X.751"X.02"	1.000 EA
HW5002A45	RETAINING RING,WALDES TRUARC N5002-118	1.000 EA
BH1163A02	SCE88 INA NEEDLE ROL SM21	1.000 EA
HA4021A05	1/16 NPSF-HX SOC PIPE PLUG TAPER DRY SEA	1.000 EA
24EP3102A01L	EP,24DC 0DE CL 0.63P4	1.000 EA
HW5109A13	WASHER, WAVE SPRING FOR 26MM BORE SMALLE	1.000 EA
BP4529SP	BRUSH TUBE HOLDER:BBR1097	1.000 EA
BP4530SP	BRUSH TUBE CAP AE-57	1.000 EA
80XN1032A04	10-32 X 1/4 SET SCREW	2.000 EA
LD0110A04	ASM,CABLE 18-3 SJTO BR,BL,G/Y, 40"	1.000 EA
55XT0632G03	6-32 X 0.187 RD HD PHILLIPS, SERRATED	1.000 EA
WD4102A01	STRN RELIEF HEYCO #1214/M.P. 23MPO6L10	1.000 EA
HA3100A31	THRUBOLT 10-32 X 6.500	2.000 EA
HW1004A10	WASHER,LOCK,#10 INT. TOOTH	2.000 EA
BGS00977	SHAFT,ASSY PSL LONG INT1 3RED 2.0/5.0	1.000 EA
BGS01765	SHAFT,ASSY PSL LONG INT2 4RED 5.0/2.0	1.000 EA
BGS01764	SHAFT,ASSY PSL LONG OUTP 3RED 0.0/5.0	1.000 EA
CG0012A01BL	CAP, PSL GEAR HEAD	1.000 EA

Parts List (continued)		
Part Number	Description	Quantity
BH1163A03	SCE1212 INA NEEDLE ROLLER BBG1027	1.000 EA
RM1020A22	O-RING .070 X 4.527	1.000 EA
HW4600D39	SEAL, .750 X 1.250 X .250 SINGLE	1.000 EA
60XM2520A12	SCREW,PAN TORX 1/4-20X.750 THREAD FORMIN	4.000 EA
MJ1000B02	KLUB. GH6-460 GEAR OIL 1 LITER	0.112 GA
BMH1910	KEY 3/16X3/16X1 1/8 AUTO X	1.000 EA
NP1220A08	NP,DC STD AD NONE V GEAR MOTOR CE CUL	1.000 EA
LB5040	INSTRUCTION TAG, AC & DC	1.000 EA
CPA1000	PACKING GROUP STD. SINGLE	1.000 EA
LB1171	LABEL CARTON 6X6 ON LINE BLANK ROLLS	1.000 EA
MG2000A14	RUST VETO 342 RUST INHIBITOR	0.001 GA
ME4000	.375-.75" DIA.#SW-04 WOVEN SHAFT PROTECT	0.125 FT

Accessories		
Part Number	Description	Multiplier
LB74	"L" BRACKET FOR PSL/PSLH UNDER 20 LBS.	A8
BC130	FRAC DC ANALOG,115AC,50/60HZ,3A,1	E9
BC138	KBWM-120 120VAC .25-HP SCR CTL, N	E9
BC140	CS2934A,120/240VAC .5/1-HP SCR CTL,NEMA	E9
BC140-FBR	W/FOR BRAKE REV SWITCH	E9
BR0050	PLUG IN RESISTOR	E9



24A614Z017G7

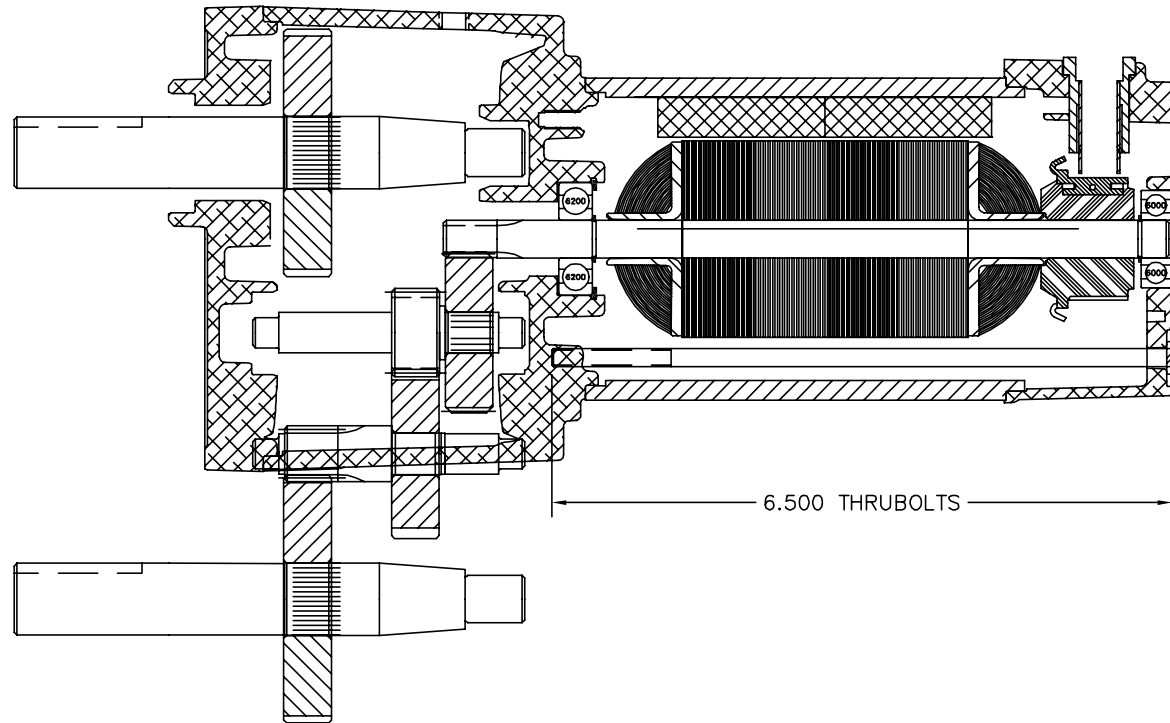

CUSTOMER IS RESPONSIBLE FOR DETERMINING THAT MOTOR PERFORMANCE IS SUITABLE IN THE APPLICATION.

REV. DESC: UPDATE DIMS.

REV. LTR: A	VERSION: 01	TDR: 000000404419
24A614Z017G7	FILE: \CKA\00029\549	REVISED: 10:50:41 08/04/2006
	MTL: -	BY: CKGLEHO

**BALDOR ELECTRIC Co.**

LY,24DC PSL DOM TENV .750 X 2.00 EXT. 4X 1/4 MTG HOLES

24A614Z017G7

CD1899

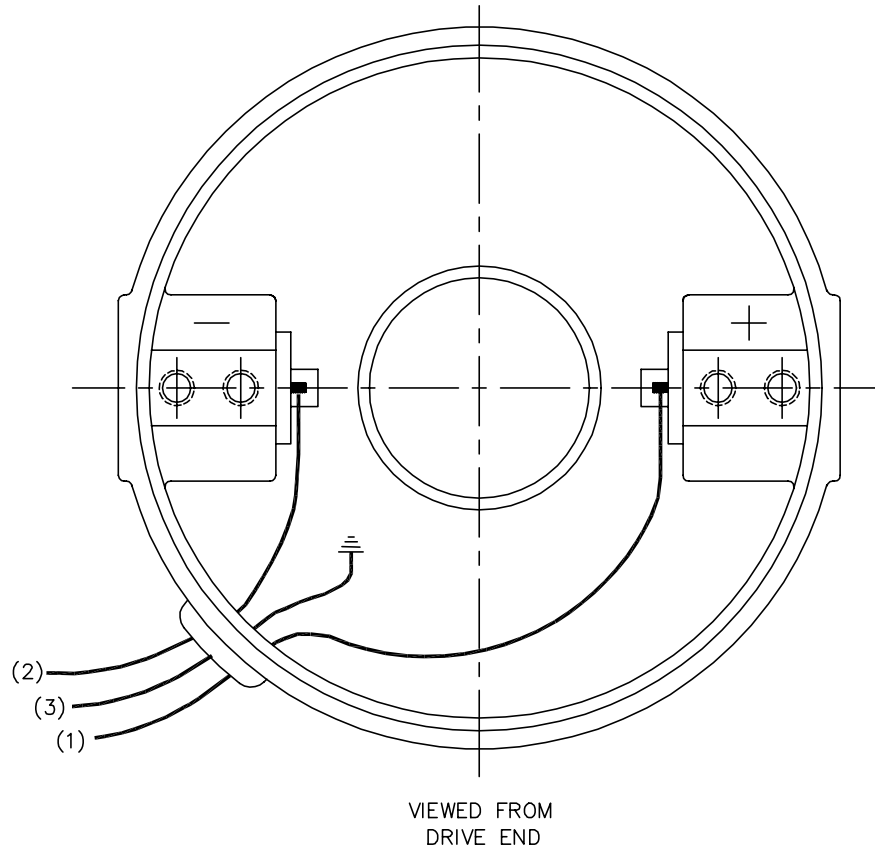

(1) COLOR MAY BE  
RED  
WHT  
BLU

(2) COLOR MAY BE  
BLK  
BRN

(3) COLOR WHEN REQ.  
GRN  
GRN/YEL

VIEWED FROM  
DRIVE END

REV. DESC: NEW			
REV. LTR: -	BY: PAW	REVISED: 09:06:34 09/16/2004	TDR: 341564
668100		FILE: CKA00025830	REF: CD1899
		MTL: -	

**BALDOR ELECTRIC Co.**

PM,2LD,REV,TANG,CK

CD1899