

# **BALDOR® • RELIANCE**

**Product Information Packet**

**ELECTRIC MOTOR WHOLESAL.COM**

**M2571T-4**

**350HP,3555RPM,3PH,60HZ,445TS,ODP,FOOT,**

| Part Detail |                    |             |         |                |           |               |            |
|-------------|--------------------|-------------|---------|----------------|-----------|---------------|------------|
| Revision:   | C                  | Status:     | PRD/A   | Change #:      |           | Proprietary:  | No         |
| Type:       | AC                 | Prod. Type: | A44068M | Elec. Spec:    | A44WG1572 | CD Diagram:   |            |
| Enclosure:  | PROT               | Mfg Plant:  |         | Mech. Spec:    |           | Layout:       |            |
| Frame:      | 445TS              | Mounting:   | F1      | Poles:         | 02        | Created Date: | 10-19-2010 |
| Base:       |                    | Rotation:   | R       | Insulation:    | B         | Eff. Date:    | 06-07-2011 |
| Leads:      | 6#2 (02 per group) | Literature: |         | Elec. Diagram: |           | Replaced By:  |            |

| Nameplate NP2301L |            |                         |          |                       |      |             |            |
|-------------------|------------|-------------------------|----------|-----------------------|------|-------------|------------|
| CAT.NO.           | M2571T-4   | SPEC NO.                | P44G6701 |                       |      |             |            |
| HP                | 350        | AMPS                    | 398      | VOLTS                 | 460  | DESIGN      | B          |
| FRAME             | 445TS      | RPM                     | 3555     | HZ                    | 60   | AMB         | 40 SF 1.15 |
| DRIVE END BEARING | 65BC03J30X | PHASE                   | 3        | DUTY                  | CONT | INSUL.CLASS | B          |
| OPP D.E. BEARING  | 65BC03J30X | TYPE                    | P        | ENCL                  | DP   | CODE        | E          |
| SER.NO.           |            | POWER FACTOR            | 86.7     | NEMA-NOM-EFFICIENCY   | 95   |             |            |
|                   |            | MAX CORR KVAR           | 60.0     | GUARANTEED EFFICIENCY | 94.5 |             |            |
|                   |            | NEMA NOM/CSA QUOTED EFF |          |                       |      |             |            |
|                   |            | MOTOR WEIGHT            |          |                       |      |             |            |

| Parts List  |                                     |          |
|-------------|-------------------------------------|----------|
| Part Number | Description                         | Quantity |
| SA209081    | SA P44G6701                         | 1.000 EA |
| RA196344    | RA P44G6701                         | 1.000 EA |
| 613-6PU     | N/P (RELEASE QTY 10,000)            | 1.000 EA |
| NP2301L     | BALDOR RELIANCE INDUSTRIAL MTR, SS, | 1.000 EA |
| 000692000VD | N/P (REL QTY 4000)                  | 1.000 EA |
| 421948044   | LABEL, MYLAR                        | 1.000 EA |
| 004824015A  | GREASE POLYREX EM                   | 0.544 LB |
| 032018028CK | HHCS 3/8-16X3-1/2 PLTD.             | 3.000 EA |
| 032018028EK | HHCS 5/8-11X3-1/2L PLTD             | 4.000 EA |
| 034000012AB | WSHR 1/4 STD. PLATED                | 4.000 EA |
| 034017012AB | LCKW 1/4 STD. PLATED                | 4.000 EA |
| 034690001AB | SQHDPLG,ODE COND                    | 1.000 EA |
| 034690002AB | PPLG 1/4" PLTD.                     | 1.000 EA |
| 089438082A  | BRKT 440 089438081WCB               | 1.000 EA |
| 405851012AB | SPACE                               | 4.000 EA |
| 410700004F  | WSHR                                | 1.000 EA |
| 702611001A  | BAFFL 440 SUB PAINT                 | 1.000 EA |
| 032018028CK | HHCS 3/8-16X3-1/2 PLTD.             | 3.000 EA |
| 032018028EK | HHCS 5/8-11X3-1/2L PLTD             | 4.000 EA |
| 032018008BK | HHCS 5/16-18X1L PLATED              | 4.000 EA |
| 032018008DK | HHCS 1/2-13X1 PLATED                | 4.000 EA |
| 034000012AB | WSHR 1/4 STD. PLATED                | 4.000 EA |
| 034017012AB | LCKW 1/4 STD. PLATED                | 4.000 EA |
| 034690001AB | SQHDPLG,ODE COND                    | 1.000 EA |

| Parts List (continued) |  |          |
|------------------------|--|----------|
| Part Number            | Description                              | Quantity |
| 034690002AB            | PPLG 1/4" PLTD.                          | 1.000 EA |
| 089438082A             | BRKT 440 089438081WCB                    | 1.000 EA |
| 405851012AB            | SPACE                                    | 4.000 EA |
| 702611001A             | BAFFL 440 SUB PAINT                      | 1.000 EA |
| 033512004LB            | HHTTS 1/4-20X1/2 PLTD.                   | 1.000 EA |
| 067053014A             | GASK 440                                 | 1.000 EA |
| 076870000B             | +CBCST BLKT - 440                        | 1.000 EA |
| 076871000A             | +CBOX CVR BLKT - 449                     | 1.000 EA |
| 406056008A             | TERBD 440                                | 1.000 EA |
| 415000003D             | T/LUG 897-777 KPA25/G16                  | 1.000 EA |
| MG1025G05              | PAINT 789.201 (WILCO) DARK GRAY METALLIC | 0.250 GA |
| 033775004EA            | DRSCR #6-1/4 304 S.S.                    | 2.000 EA |
| 034180024HA            | KEY 5/8X5/8X3 L                          | 1.000 EA |

|           |             |                   |              |                                       |                |       |
|-----------|-------------|-------------------|--------------|---------------------------------------|----------------|-------|
| REL. S.O. | FRAME       | HP                | TYPE         | PHASE/HERTZ                           | RPM            | VOLTS |
|           | 445TS       | 350               | P            | 3/60                                  | 3555           | 460   |
| AMPS      | DUTY        | AMB °C/<br>INSUL. | S.F.         | NEMA<br>DESIGN                        | CODE<br>LETTER | ENCL. |
| 398       | CONT        | 40/B              | 1.15         | B                                     | E              | PROT  |
| E/S       | ROTOR       | TEST<br>S.O.      | TEST<br>DATE | STATOR RES. @25 °C<br>(BETWEEN LINES) |                |       |
| 498489    | 418143013HE | ---               | ---          | .0135                                 |                |       |

| PERFORMANCE |      |         |      |                |              |  |
|-------------|------|---------|------|----------------|--------------|--|
| LOAD        | HP   | AMPERES | RPM  | POWER FACTOR % | EFFICIENCY % |  |
| NO LOAD     | 0    | 98.0    | 3600 | 5.76           | 0            |  |
| 1/4         | 87.6 | 137     | 3589 | 64.7           | 92.8         |  |
| 2/4         | 175  | 207     | 3578 | 82.9           | 95.1         |  |
| 3/4         | 262  | 298     | 3566 | 86.4           | 95.4         |  |
| 4/4         | 350  | 398     | 3553 | 86.7           | 95.1         |  |
| 5/4         | 438  | 501     | 3539 | 86.6           | 94.5         |  |

| SPEED TORQUE |      |                       |                   |         |  |  |
|--------------|------|-----------------------|-------------------|---------|--|--|
|              | RPM  | TORQUE<br>% FULL LOAD | TORQUE<br>LB.-FT. | AMPERES |  |  |
| LOCKED ROTOR | 0    | 163                   | 844               | 2025    |  |  |
| PULL UP      | 1800 | 130                   | 675               | 1850    |  |  |
| BREAKDOWN    | 3429 | 202                   | 1045              | 1296    |  |  |
| FULL LOAD    | 3553 | 100                   | 517               | 398     |  |  |

AMPERES SHOWN FOR 460. VOLT CONNECTION. IF OTHER VOLTAGE CONNECTIONS ARE AVAILABLE, THE AMPERES WILL VARY INVERSELY WITH THE RATED VOLTAGE

REMARKS: TYPICAL DATA  
XE MOTOR-NEMA NOM. EFF. 95.0%

|               |         |              |                  |                         |
|---------------|---------|--------------|------------------|-------------------------|
| <b>BALDOR</b> | DR. BY  | J.J.HARRISON | <b>A-C MOTOR</b> |                         |
|               | CK. BY  | W.I.SMITH    |                  | <b>PERFORMANCE DATA</b> |
|               | APP. BY | W.I.SMITH    |                  |                         |
|               | DATE    | 06/30/03     |                  |                         |
|               |         | ISSUE DATE   | 12/18/10         |                         |

|                  |                   |                |                           |
|------------------|-------------------|----------------|---------------------------|
| REL. S. O.       | RPM 3555          | S.F. 1.15      | ROTOR 418143013HE         |
| FRAME 445TS      | VOLTS 460         | NEMA DESIGN B  | TEST S. O. TYPICAL DATA   |
| HP 350           | AMPS 398          | CODE LETTER E  | TEST DATE ---             |
| TYPE P           | DUTY CONT         | ENCLOSURE PROT | STATOR RES. @ 25 °C .0135 |
| PHASE/HERTZ 3/60 | AMB °C/INSUL 40/B | E/S 498489     | OHMS (BETWEEN LINES)      |

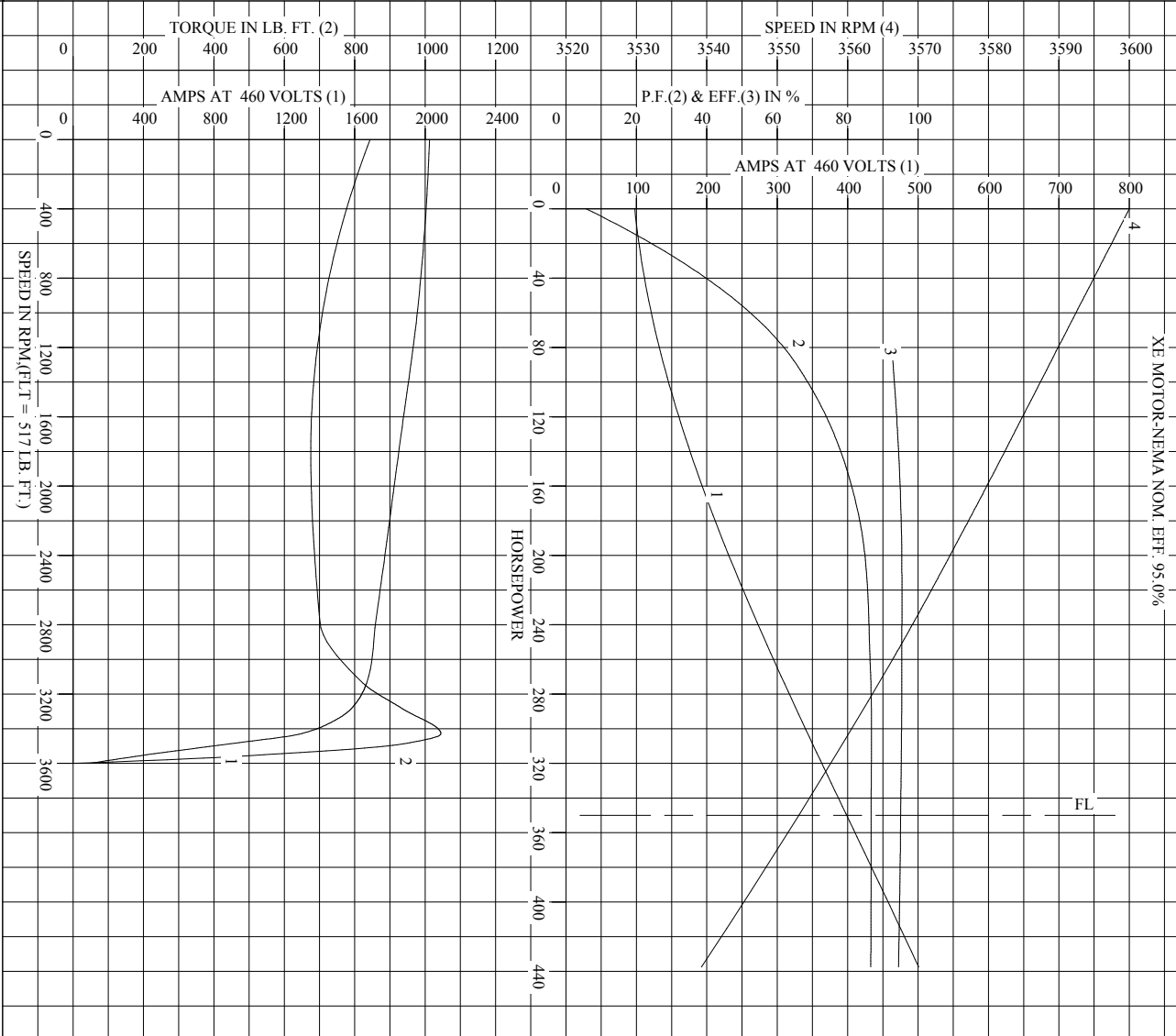

AMPERES SHOWN FOR 460 VOLT CONNECTION, IF OTHER VOLTAGE CONNECTIONS ARE AVAILABLE, THE AMPERES WILL VARY INVERSELY WITH THE RATED VOLTAGE.

|  |                     |  |
|--|---------------------|--|
|  | DR. BY J. HARRISON  | <b>A-C MOTOR<br/>PERFORMANCE<br/>CURVES</b><br>A44WG1572-R001<br>ISSUE DATE 12/18/10 |
|  | CK. BY W. L. SMITH  |  |
|  | APP. BY W. L. SMITH |  |
|  | DATE 06/30/03       |  |

Printed on 12/18/10 7:38 @ psecs-motoreng

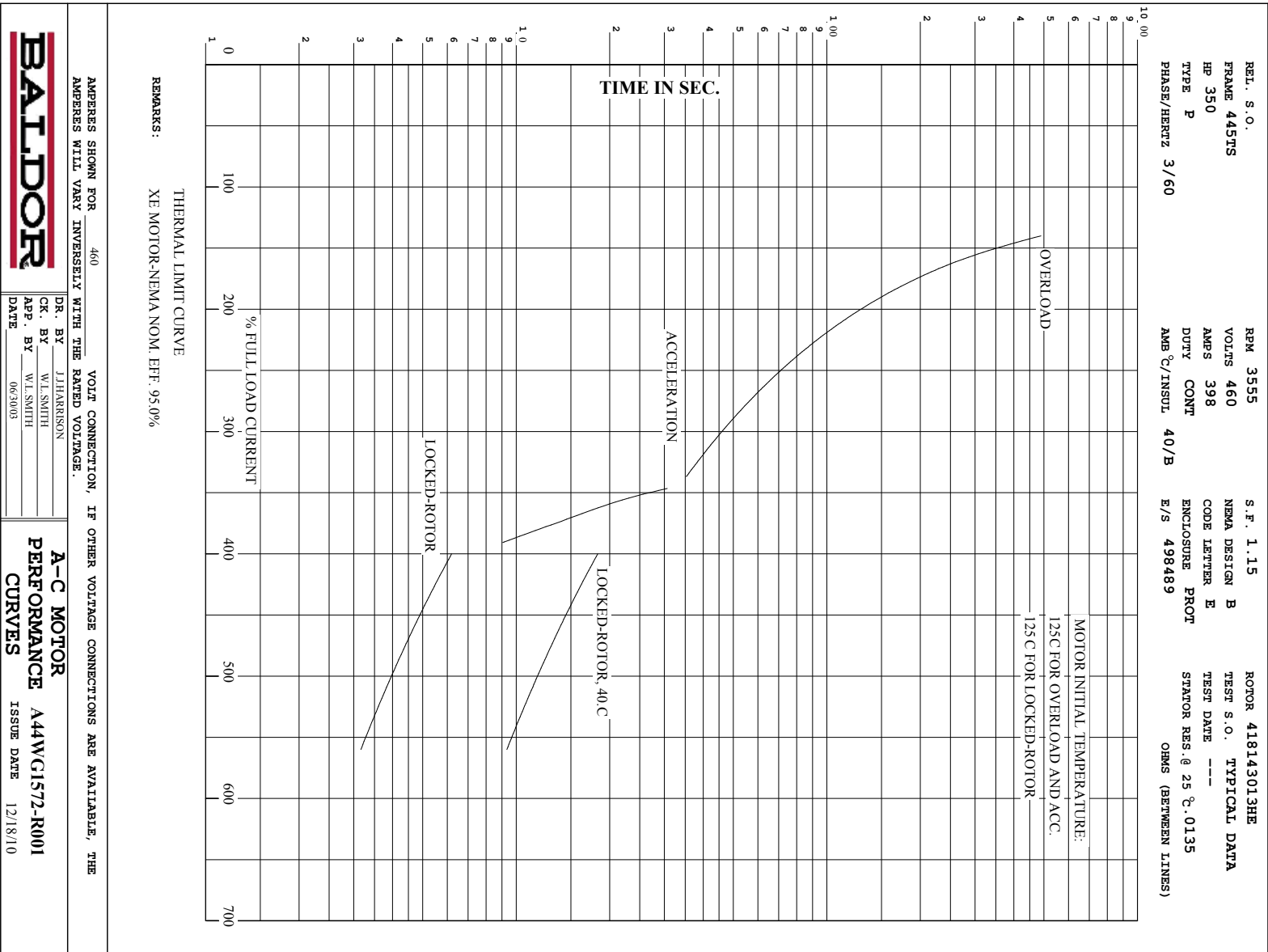

AMPERES SHOWN FOR 460 VOLT CONNECTION, IF OTHER VOLTAGE CONNECTIONS ARE AVAILABLE, THE AMPERES WILL VARY INVERSELY WITH THE RATED VOLTAGE.

|         |            |
|---------|------------|
| DR. BY  | J.HARRISON |
| CK. BY  | W.L.SMITH  |
| APP. BY | W.L.SMITH  |
| DATE    | 06/30/03   |

**A-C MOTOR**  
**PERFORMANCE CURVES**

A44WG1572-R001  
ISSUE DATE 12/8/10

604989-050

**DUTY MASTER ALTERNATING CURRENT MOTORS**

ENCLOSURE: PROTECTED & WEATHERPROTECTED I SQUIREL-CAGE INDUCTION  
 TOTALLY ENCLOSED COOLING: SELF-VENTILATED  
 MOUNTING: FOOT NON-VENTILATED

FRAMES 445T THRU 449TS ABOVE NEMA RATINGS

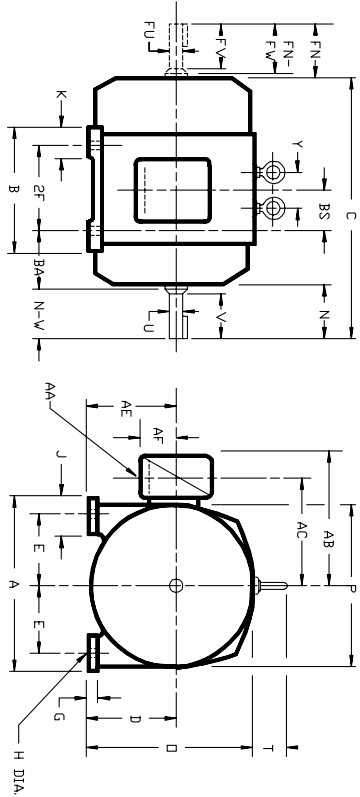

DIMENSIONS ARE IN INCHES

| FRAME | A     | D(2)  | E    | G    | H  | J    | D     | P     | BA   | K    | T    | Y (6) |
|-------|-------|-------|------|------|----|------|-------|-------|------|------|------|-------|
| 445T  | 21.00 | 11.00 | 9.00 | 1.12 | 81 | 3.25 | 23.62 | 24.25 | 7.50 | 5.25 | 3.25 | ---   |
| 445TS | 21.00 | 11.00 | 9.00 | 1.12 | 81 | 3.25 | 23.62 | 24.25 | 7.50 | 5.25 | 3.25 | ---   |
| 447T  | 21.00 | 11.00 | 9.00 | 1.12 | 81 | 3.25 | 24.25 | 24.25 | 7.50 | 3.25 | 4.25 | 5.00  |
| 447TS | 21.00 | 11.00 | 9.00 | 1.12 | 81 | 3.25 | 24.25 | 24.25 | 7.50 | 3.25 | 4.25 | 5.00  |
| 449T  | 21.00 | 11.00 | 9.00 | 1.12 | 81 | 3.25 | 24.25 | 24.25 | 7.50 | 3.25 | 4.25 | 5.00  |
| 449TS | 21.00 | 11.00 | 9.00 | 1.12 | 81 | 3.25 | 24.25 | 24.25 | 7.50 | 3.25 | 4.25 | 5.00  |

| FRAME | C     | BS    | B     | DRIVE END SHAFT AND KEY |      |      |       | OPPOSITE DRIVE END SHAFT AND KEY |      |       |       | V.T. (L3R) |       |      |      |      |       |
|-------|-------|-------|-------|-------------------------|------|------|-------|----------------------------------|------|-------|-------|------------|-------|------|------|------|-------|
|       |       |       |       | N                       | N-1  | U(3) | V     | SO. KEY                          | FN   | FN-FV | FU(3) |            | FV    |      |      |      |       |
| 445T  | 39.56 | 8.25  | 19.00 | 16.50                   | 8.94 | 8.50 | 3.375 | 8.25                             | 6.88 | 8.75  | 6.31  | 5.88       | 2.375 | 5.62 | 4.25 | 6.25 | 14.0  |
| 445TS | 39.81 | 8.25  | 19.00 | 16.50                   | 8.94 | 8.50 | 3.375 | 8.25                             | 6.88 | 8.75  | 6.31  | 5.88       | 2.375 | 5.62 | 4.25 | 6.25 | 14.0  |
| 447T  | 43.06 | 10.00 | 22.50 | 20.00                   | 8.94 | 8.50 | 3.375 | 8.25                             | 6.88 | 8.75  | 6.31  | 5.88       | 2.375 | 5.62 | 4.25 | 6.25 | 17.30 |
| 447TS | 43.31 | 10.00 | 22.50 | 20.00                   | 8.94 | 8.50 | 3.375 | 8.25                             | 6.88 | 8.75  | 6.31  | 5.88       | 2.375 | 5.62 | 4.25 | 6.25 | 17.30 |
| 449T  | 48.06 | 12.50 | 27.50 | 25.00                   | 8.94 | 8.50 | 3.375 | 8.25                             | 6.88 | 8.75  | 6.31  | 5.88       | 2.375 | 5.62 | 4.25 | 6.25 | 21.00 |
| 449TS | 44.31 | 12.50 | 27.50 | 25.00                   | 8.94 | 8.50 | 3.375 | 8.25                             | 6.88 | 8.75  | 6.31  | 5.88       | 2.375 | 5.62 | 4.25 | 6.25 | 21.00 |

| FRAME | CONDUIT BOX |       | STANDARD | AF    |       |      |
|-------|-------------|-------|----------|-------|-------|------|
|       | AA          | AE    |          |       |       |      |
| 445T  | 4           | 12.00 | 11.00    | 22.75 | 17.50 | 7.00 |
| 445TS | 4           | 12.00 | 11.00    | 22.75 | 17.50 | 7.00 |
| 447T  | 4           | 12.00 | 11.00    | 22.75 | 17.50 | 7.00 |
| 447TS | 4           | 12.00 | 11.00    | 22.75 | 17.50 | 7.00 |
| 449T  | 4           | 12.00 | 11.00    | 22.75 | 17.50 | 7.00 |
| 449TS | 4           | 12.00 | 11.00    | 22.75 | 17.50 | 7.00 |

- (1) SPECIAL DIMENSIONS ON THIS LINE
  - (2) \*DP VARIES +.00, -.06
  - (3) \*U & \*FV VARY +.00, -.01
  - (4) WEATHERPROOF CONDUIT BOX SUPPLIED ONLY WHEN SPECIFIED
  - (5) DIMENSIONS SHOWN ARE FOR PROTECTED MOTORS,  
FOR TENV MOTORS \*AB=23.37, \*AC=18.12
  - (6) 445 FRAME HAS ONE EYEBOLT C OF FRAME.
- CONDUIT BOX LOCATED ON OPPOSITE SIDE WHEN F-2, W-1, W-4, W-5, V-7, OR C-1 MOUNTING IS SPECIFIED. STANDARD DOUBLE SHAFT SUPPLIED ONLY WHEN SPECIFIED. IF MOUNTING CLEARANCE DETAILS ARE REQUIRED CONSULT FACTORY. MAXIMUM PERMISSIBLE SHAFT ROUNDOFF WHEN MEASURED AT END OF STANDARD SHAFT EXTENSION IS .003 T.I.R.

CUSTOMER IS RESPONSIBLE FOR DETERMINING THAT BALDOR'S PRODUCT WILL PERFORM SUITABLY IN THE INTENDED APPLICATION.

|                          |                              |                   |
|--------------------------|------------------------------|-------------------|
| REV. DESC: LOADED TO BUS | VERSION: 01                  | TDR: 000000561165 |
| REV. LTR: A              | REVISED: 08:19:54 10/18/2010 | BY: RAGRA         |
| FILE: \RAG\00012\156     |                              |                   |
| MTL: -                   |                              |                   |

**BALDOR**  
 DIM SHEET PROT/WEATHER TENV 445T-449TS ABOVE NEMA  
 SH 1 of 1

FRAME- \_\_\_\_\_ TYPE- \_\_\_\_\_ CERTIFIED FOR- \_\_\_\_\_  
 ORDER- \_\_\_\_\_ ITEM- \_\_\_\_\_ HP- \_\_\_\_\_ RPM- \_\_\_\_\_ PH- \_\_\_\_\_ HZ- \_\_\_\_\_ VOLTS- \_\_\_\_\_  
 SALES ORDER- \_\_\_\_\_ APPROVED BY- \_\_\_\_\_ DATE \_\_\_\_\_

050-686409

416820-008

# A-C MOTOR CONNECTION DIAGRAM

STANDARD 6 LEAD

Y START - DELTA RUN

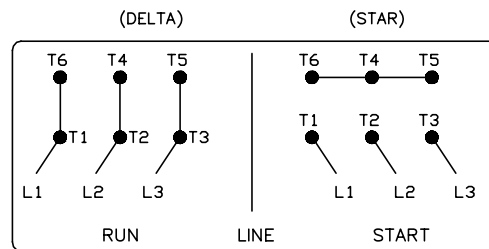
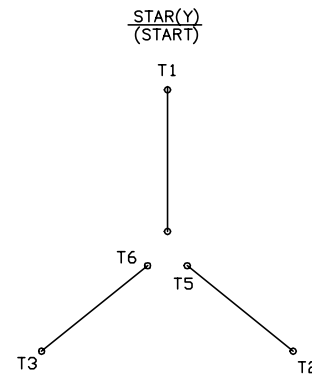
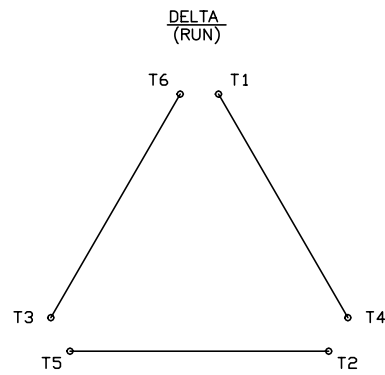

< N. P. 1767-DC >

416820-008

|                                    |                              |                   |
|------------------------------------|------------------------------|-------------------|
| REV. DESC: CORRECT VIEW ON DRAWING |                              |                   |
| REV. LTR: C                        | VERSION: 03                  | TDR: 000000579787 |
| FILE: \RAG\00001\808               | REVISED: 01:18:33 03/29/2011 |                   |
| MTL: -                             | BY: RAGRA                    |                   |

**BALDOR**

CONNECT DIAGRAM STD 6 LEAD Y START DELTA RUN

SH 1 of 1

**BALDOR • RELIANCE**

**Integral Horsepower  
AC Induction Motors  
ODP, WPI Enclosures  
TENV, TEAO, TEFC Enclosure  
Explosion Proof**

**Installation & Operating Manual**

3/09

MN408

Any trademarks used in this manual are the property of their respective owners.

**Table of Contents**

|   |      |
|---|------|
| <b>Section 1</b>  |      |
| <b>General Information</b> .....  |      |
| Overview .....  | 1-1  |
| Limited Warranty .....  | 1-1  |
| Safety Notice .....   | 1-1  |
| Receiving .....   | 1-2  |
| Storage .....   | 1-2  |
| Extended Storage .....  | 1-3  |
| Greater than 6 months .....   | 1-3  |
| Greater than 18 months .....  | 1-3  |
| Unpacking .....   | 1-4  |
| Handling .....  | 1-4  |
| <b>Section 2</b>  |      |
| <b>Installation &amp; Operation</b> .....   |      |
| Overview .....  | 2-1  |
| Location .....  | 2-1  |
| Mounting .....  | 2-1  |
| Frame Mounting Holes .....  | 2-2  |
| Alignment .....   | 2-2  |
| Doweling & Bolting .....  | 2-3  |
| Guarding .....  | 2-3  |
| Power Connection .....  | 2-3  |
| Grounding .....   | 2-3  |
| Conduit Box .....   | 2-3  |
| AC Power .....  | 2-4  |
| Rotation .....  | 2-4  |
| Connection Diagrams .....   | 2-5  |
| First Time Start Up .....   | 2-7  |
| Initial Lubrication .....   | 2-8  |
| Test for General Condition .....  | 2-8  |
| Coupled Start Up .....  | 2-8  |
| Jogging and Repeated Starts .....   | 2-8  |
| Heating .....   | 2-8  |
| Hazardous Locations .....   | 2-8  |
| Selection .....   | 2-8  |
| Protection Concepts .....   | 2-8  |
| Repair of Motors used in Hazardous Locations .....  | 2-10 |
| <b>Section 3</b>  |      |
| <b>Maintenance &amp; Troubleshooting</b> .....  |      |
| General Inspection .....  | 3-1  |
| Relubrication & Bearings .....  | 3-1  |
| Type of Grease .....  | 3-1  |
| Relubrication Intervals .....   | 3-2  |
| Relubrication Procedure .....   | 3-4  |
| Troubleshooting Chart .....   | 3-5  |
| Suggested bearing and winding RTD setting guidelines for Non-Hazardous Locations ONLY ..... | 3-6  |

ii Table of Contents

MN408

## Section 1 General Information

---

### Overview

This manual contains general procedures that apply to Baldor Motor products. Be sure to read and understand the Safety Notice statements in this manual. For your protection, do not install, operate or attempt to perform maintenance procedures until you understand the **Warning and Caution** statements. A **Warning** statement indicates a possible unsafe condition that can cause harm to personnel.

A **Caution** statement indicates a condition that can cause damage to equipment.

### Important:

**This instruction manual is not intended to include a comprehensive listing of all details for all procedures required for installation, operation and maintenance. This manual describes general guidelines that apply to most of the motor products shipped by Baldor. If you have a question about a procedure or are uncertain about any detail, Do Not Proceed. Please contact your Baldor distributor for more information or clarification.**

Before you install, operate or perform maintenance, become familiar with the following:

- NEMA Publication MG-2, Safety Standard for Construction and guide for Selection, Installation and Use of Electric Motors and Generators.
- IEC 34-1 Electrical and IEC72-1 Mechanical specifications
- ANSI C51.5, the National Electrical Code (NEC) and local codes and practices.

### Limited Warranty

[www.baldor.com/suport/warranty\\_standard.asp](http://www.baldor.com/suport/warranty_standard.asp)

### Safety Notice:

This equipment contains high voltage! Electrical shock can cause serious or fatal injury. Only qualified personnel should attempt installation, operation and maintenance of electrical equipment.

Be sure that you are completely familiar with NEMA publication MG-2, safety standards for construction and guide for selection, installation and use of electric motors and generators, the National Electrical Code and local codes and practices. Unsafe installation or use can cause conditions that lead to serious or fatal injury. Only qualified personnel should attempt the installation, operation and maintenance of this equipment.

### WARNING:

**Do not touch electrical connections before you first ensure that power has been disconnected. Electrical shock can cause serious or fatal injury. Only qualified personnel should attempt the installation, operation and maintenance of this equipment.**

### WARNING:

**Disconnect all electrical power from the motor windings and accessory devices before disassembly of the motor. Electrical shock can cause serious or fatal injury.**

### WARNING:

**Be sure the system is properly grounded before applying power. Do not apply AC power before you ensure that all grounding instructions have been followed. Electrical shock can cause serious or fatal injury. National Electrical Code and Local codes must be carefully followed.**

### WARNING:

**Avoid extended exposure to machinery with high noise levels. Be sure to wear ear protective devices to reduce harmful effects to your hearing.**

### WARNING:

**Surface temperatures of motor enclosures may reach temperatures which can cause discomfort or injury to personnel accidentally coming into contact with hot surfaces. When installing, protection should be provided by the user to protect against accidental contact with hot surfaces. Failure to observe this precaution could result in bodily injury.**

### WARNING:

**This equipment may be connected to other machinery that has rotating parts or parts that are driven by this equipment. Improper use can cause serious or fatal injury. Only qualified personnel should attempt to install operate or maintain this equipment.**

### WARNING:

**Do not by-pass or disable protective devices or safety guards. Safety features are designed to prevent damage to personnel or equipment. These devices can only provide protection if they remain operative.**

### WARNING:

**Avoid the use of automatic reset devices if the automatic restarting of equipment can be hazardous to personnel or equipment.**

### WARNING:

**Be sure the load is properly coupled to the motor shaft before applying power. The shaft key must be fully captive by the load device. Improper coupling can cause harm to personnel or equipment if the load decouples from the shaft during operation.**

### WARNING:

**UL Listed motors must only be serviced by UL Approved Authorized Baldor Service Centers if these motors are to be returned to a hazardous and/or explosive atmosphere.**

### WARNING:

**Thermostat contacts automatically reset when the motor has slightly cooled down. To prevent injury or damage, the control circuit should be designed so that automatic starting of the motor is not possible when the thermostat resets.**

**Safety Notice** Continued

- WARNING:** Use proper care and procedures that are safe during handling, lifting, installing, operating and maintaining operations. Improper methods may cause muscle strain or other harm.
- WARNING:** Pacemaker danger – Magnetic and electromagnetic fields in the vicinity of current carrying carrying conductors and permanent magnet motors can result result in a serious health hazard to persons with cardiac pacemakers, metal implants, and hearing aids. To avoid risk, stay way from the area surrounding a permanent magnet motor.
- WARNING:** Before performing any motor maintenance procedure, be sure that the equipment connected to the motor shaft cannot cause shaft rotation. If the load can cause shaft rotation, disconnect the load from the motor shaft before maintenance is performed. Unexpected mechanical rotation of the motor parts can cause injury or motor damage.
- WARNING:** Do not use non UL/CSA listed explosion proof motors in the presence of flammable or combustible vapors or dust. These motors are not designed for atmospheric conditions that require explosion proof operation.
- WARNING:** Motors that are to be used in flammable and/or explosive atmospheres must display the UL label on the nameplate along with CSA listed logo. Specific service conditions for these motors are defined in NFPA 70 (NEC) Article 500.
- WARNING:** Guards must be installed for rotating parts such as couplings, pulleys, external fans, and unused shaft extensions, should be permanently guarded to prevent accidental contact by personnel. Accidental contact with body parts or clothing can cause serious or fatal injury.
- Caution:** To prevent premature equipment failure or damage, only qualified maintenance personnel should perform maintenance.
- Caution:** Do not over tension belts. Excess tension may damage the motor or driven equipment.
- Caution:** Do not over-lubricate motor as this may cause premature bearing failure.
- Caution:** Do not lift the motor and its driven load by the motor lifting hardware. The motor lifting hardware is adequate for lifting only the motor. Disconnect the load (gears, pumps, compressors, or other driven equipment) from the motor shaft before lifting the motor.
- Caution:** If eye bolts are used for lifting a motor, be sure they are securely tightened. The lifting direction should not exceed a 20° angle from the shank of the eye bolt or lifting lug. Excessive lifting angles can cause damage.
- Caution:** To prevent equipment damage, be sure that the electrical service is not capable of delivering more than the maximum motor rated amps listed on the rating plate.
- Caution:** If a HI POT test (High Potential Insulation test) must be performed, follow the precautions and procedure in NEMA MG1 and MG2 standards to avoid equipment damage.
- If you have any questions or are uncertain about any statement or procedure, or if you require additional information please contact your Baldor distributor or an Authorized Baldor Service Center.
- Each Baldor Electric Motor is thoroughly tested at the factory and carefully packaged for shipment. When you receive your motor, there are several things you should do immediately.
- Receiving**
1. Observe the condition of the shipping container and report any damage immediately to the commercial carrier that delivered your motor.
  2. Verify that the part number of the motor you received is the same as the part number listed on your purchase order.
- Handling**
- Caution:** The motor should be lifted using the lifting lugs or eye bolts provided.
- Caution:** Do not lift the motor and its driven load by the motor lifting hardware. The motor lifting hardware is adequate for lifting only the motor. Disconnect the load (gears, pumps, compressors, or other driven equipment) from the motor shaft before lifting the motor.
1. Use the lugs or eye bolts provided to lift the motor. Never attempt to lift the motor and additional equipment connected to the motor by this method. The lugs or eye bolts provided are designed to lift only the motor. Never lift the motor by the motor shaft or the hood of a WP11 motor.
  2. To avoid condensation inside the motor, do not unpack until the motor has reached room temperature. (Room temperature is the temperature of the room in which it will be installed). The packing provides insulation from temperature changes during transportation.
  3. When lifting a WP11 (Weather Proof Type 2) motor, do not lift the motor by inserting lifting lugs into holes on top of the cooling hood. These lugs are to be used for hood removal only. A spreader bar should be used to lift the motor by the cast lifting lugs located on the motor frame.

4. If the motor must be mounted to a plate with the driven equipment such as pump, compressor etc., it may not be possible to lift the motor alone. For this case, the assembly should be lifted by a sling around the mounting base. The entire assembly can be lifted as an assembly for installation.

Do not lift the assembly using the motor lugs or eye bolts provided. Lugs or eye bolts are designed to lift motor only. If the load is unbalanced (as with couplings or additional attachments) additional slings or other means must be used to prevent tipping. In any event, the load must be secure before lifting. If the load is unbalanced (as with couplings or additional attachments) additional slings or other means must be used to prevent tipping. In any event, the load must be secure before lifting.

Storage requirements for motors and generators that will not be placed in service for at least six months from date of shipment:

Improper motor storage will result in seriously reduced reliability and failure. An electric motor that does not experience regular usage while being exposed to normally humid atmospheric conditions is likely to develop rust in the bearings or rust particles from surrounding surfaces may contaminate the bearings. The electrical insulation may absorb an excessive amount of moisture leading to the motor winding failure.

A wooden crate "shell" should be constructed to secure the motor during storage. This is similar to an export box but the sides & top must be secured to the wooden base with lag bolts (not nailed as export boxes are) to allow opening and reclosing many times without damage to the "shell".

Minimum resistance of motor winding insulation is 5 Meg ohms or the calculated minimum, which ever is greater. Minimum resistance is calculated as follows:  $R_m = kV + 1$

where: (R<sub>m</sub> is minimum resistance to ground in Meg-Ohms and

kV is rated nameplate voltage defined as Kilo-Volts.)

Example: For a 480VAC rated motor  $R_m = 1.48 \text{ meg-ohms}$  (use 5 MΩ).

For a 4160VAC rated motor  $R_m = 5.16 \text{ meg-ohms}$ .

#### Preparation for Storage

1. Some motors have a shipping brace attached to the shaft to prevent damage during transportation. The shipping brace, if provided, must be removed and stored for future use. The brace must be reinstalled to hold the shaft firmly in place against the bearing before the motor is moved.
2. Store in a clean, dry, protected warehouse where control is maintained as follows:
  - a. Shock or vibration must not exceed 2 mils maximum at 60 hertz, to prevent the bearings from brinelling. If shock or vibration exceeds this limit vibration isolation pads must be used.
  - b. Storage temperatures of 10°C (50°F) to 49°C (120°F) must be maintained.
  - c. Relative humidity must not exceed 60%.
  - d. Motor space heaters (when present) are to be connected and energized whenever there is a possibility that the storage ambient conditions will reach the dew point. Space heaters are optional.

Note: Remove motor from containers when heaters are energized, reprotect if necessary.

3. Measure and record the resistance of the winding insulation (dielectric withstand) every 30 days of storage.
  - a. If motor insulation resistance decreases below the minimum resistance, contact your Baldor District office.
  - b. Place new desiccant inside the vapor bag and re-seal by taping it closed.
  - c. If a zipper-closing type bag is used instead of the heat-sealed type bag, zip the bag closed instead of taping it. Be sure to place new desiccant inside bag after each monthly inspection.
  - d. Place the shell over the motor and secure with lag bolts.
4. Where motors are mounted to machinery, the mounting must be such that the drains and breathers are fully operable and are at the lowest point of the motor. Vertical motors must be stored in the vertical position. Storage environment must be maintained as stated in step 2.

5. Motors with anti-friction bearings are to be greased at the time of going into extended storage with periodic service as follows:
  - a. Motors marked "Do Not Lubricate" on the nameplate do not need to be greased before or during storage.
  - b. Ball and roller bearing (anti-friction) motor shafts are to be rotated manually every 3 months and greased every 6 months in accordance with the Maintenance section of this manual.
  - c. Sleeve bearing (oil lube) motors are drained of oil prior to shipment. The oil reservoirs must be refilled to the indicated level with the specified lubricant. (see Maintenance). The shaft should be rotated monthly by hand at least 10 to 15 revolutions to distribute oil to bearing surfaces.
  - d. "Provisions for oil mist lubrication" – These motors are packed with grease. Storage procedures are the same as paragraph 5b.
  - e. "Oil Mist Lubricated" – These bearings are protected for temporary storage by a corrosion inhibitor. If stored for greater than 3 months or outdoor storage is anticipated, connected to the oil mist system while in storage. If this is not possible, add the amount of grease indicated under "Standard Condition" in Section 3, then rotate the shaft 15 times by hand.
6. All breather drains are to be fully operable while in storage (drain plugs removed). The motors must be stored so that the drain is at the lowest point. All breathers and automatic "T" drains must be operable to allow breathing and draining at points other than through the bearings around the shaft. Vertical motors should be stored in a safe stable vertical position.
7. Coat all external machined surfaces with a rust preventing material.
8. An acceptable product for this purpose is Exxon Rust Ban # 392.
8. Carbon brushes should be lifted and held in place in the holders, above the commutator, by the brush holder fingers. The commutator should be wrapped with a suitable material such as cardboard paper as a mechanical protection against damage.

#### **Non-Regreaseable Motors**

Non-regreaseable motors with "Do Not Lubricate" on the nameplate should have the motor shaft rotated 15 times to redistribute the grease within the bearing every 3 months or more often.

#### **All Other Motor Types**

Before storage, the following procedure must be performed.

1. Remove the grease drain plug, if supplied, (opposite the grease fitting) on the bottom of each bracket prior to lubricating the motor.
2. The motor with regreaseable bearing must be greased as instructed in Section 3 of this manual.
3. Replace the grease drain plug after greasing.
4. The motor shaft must be rotated a minimum of 15 times after greasing.
5. Motor Shafts are to be rotated at least 15 revolutions manually every 3 months and additional grease added every nine months (see Section 3) to each bearing.
6. Bearings are to be greased at the time of removal from storage.

#### **Removal From Storage**

1. Remove all packing material.
2. Measure and record the electrical resistance of the winding insulation resistance meter at the time of removal from storage. The insulation resistance must not be less than 50% from the initial reading recorded when the motor was placed into storage. A decrease in resistance indicates moisture in the windings and necessitates electrical or mechanical drying before the motor can be placed into service. If resistance is low, contact your Baldor District office.
3. Regrease the bearings as instructed in Section 3 of this manual.
4. Reinstall the original shipping brace if motor is to be moved. This will hold the shaft firmly against the bearing and prevent damage during movement.

**Equipment Marking for IEC Certified Product**

IEC certified products have special markings that identify the protection concept and environment requirements. An example is shown in Figure 3-1.

**Figure 3-1 IEC Certified Product Markings**

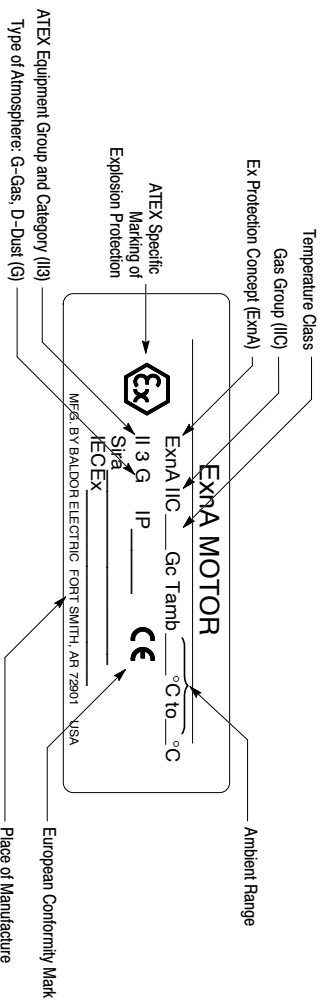

**Specific Conditions of Use:**

If the motor certificate number is followed by the symbol "X", this indicates that the motor has specific conditions of use which are indicated on the certificate. It is necessary to review the product certification certificate in conjunction with this instruction manual.

**Operation On Frequency Converters:**

If the motor is evaluated for operation with an adjustable speed drive, the type of converter (for example PWM for Pulse Width Modulated) and safe speed ranges (for example 0-120Hz) will be specified in the certification documents or on motor nameplates. It is necessary to consult the adjustable speed drive manual for proper set up.

1-6 General Information

MN408

## Section 2 Installation & Operation

### Overview

Installation should conform to the National Electrical Code as well as local codes and practices. When other devices are coupled to the motor shaft, be sure to install protective devices to prevent future accidents. Some protective devices include, coupling, belt guard, chain guard, shaft covers etc. These protect against accidental contact with moving parts. Machinery that is accessible to personnel should provide further protection in the form of guard rails, screening, warning signs etc.

### Location

It is important that motors be installed in locations that are compatible with motor enclosure and ambient conditions. Improper selection of the motor enclosure and ambient conditions can lead to reduced operating life of the motor.

- Proper ventilation for the motor must be provided. Obstructed airflow can lead to reduction of motor life.
- Open Drip – Proof/WPI** motors are intended for use indoors where atmosphere is relatively clean, dry, well ventilated and non–corrosive.
  - Totally Enclosed and WPII** motors may be installed where dirt, moisture or dust are present and in outdoor locations.

**Severe Duty**, IEEE 841 and Washdown Duty enclosed motors are designed for installations with high corrosion or excessive moisture conditions. These motors should not be placed into an environment where there is the presence of flammable or combustible vapors, dust or any combustible material, unless specifically designed for this type of service.

**Hazardous Locations** are those where there is a risk of ignition or explosion due to the presence of combustible gases, vapors, dust, fibers, or flyings. Facilities requiring special equipment for hazardous locations are typically classified in accordance with local requirements. In the US market, guidance is provided by the National Electric Code.

### Mounting

The motor should be installed in a location compatible with the motor enclosure and specific ambient. To allow adequate air flow, the following clearances must be maintained between the motor and any obstruction:

**Table 2-1 Enclosure Clearance**

| <b>TEFC / TENV (IC0141) Enclosures</b> |  |
|--|--|
| Fan Cover Air Intake                   | 180 – 210T Frame 1" (25mm)   |
| Fan Cover Air Intake                   | 250 – 449T Frame 4" (100mm)  |
|  | IEC 112 – 132 1" (25mm)  |
|  | IEC 160 – 280 4" (100mm)   |
| Exhaust                                | Envelope equal to the P Dimension on the motor dimension sheet   |
| <b>OPEN/Protected Enclosures</b>       |  |
| Bracket Intake                         | Same as TEFC   |
| Frame Exhaust                          | Exhaust out the sides envelope<br>A minimum of the P dimension plus 2" (50mm)<br>Exhaust out the end same as intake. |

The motor must be securely installed to a rigid foundation or mounting surface to minimize vibration and maintain alignment between the motor and shaft load. Failure to provide a proper mounting surface may cause vibration, misalignment and bearing damage.

Foundation caps and sole plates are designed to act as spacers for the equipment they support. If these devices are used, be sure that they are evenly supported by the foundation or mounting surface.

When installation is complete and accurate alignment of the motor and load is accomplished, the base should be grouted to the foundation to maintain this alignment.

The standard motor base is designed for horizontal or vertical mounting. Adjustable or sliding rails are designed for horizontal mounting only. Consult your Baldor distributor or authorized Baldor Service Center for further information.

**Frame Mounting Holes**

Some motors have standardized frames containing 6 or 8 mounting holes. 6 hole frames are not suitable for field reversal of mounting from F-1 to F-2, etc. Figure 2-2 indicates the proper mounting holes to use.

For short frame designations 182, 213, 254, 284, 324, 364, 404, 444 (NEMA)

**Figure 2-2 6 & 8 Hole Motor Frame Mounting**

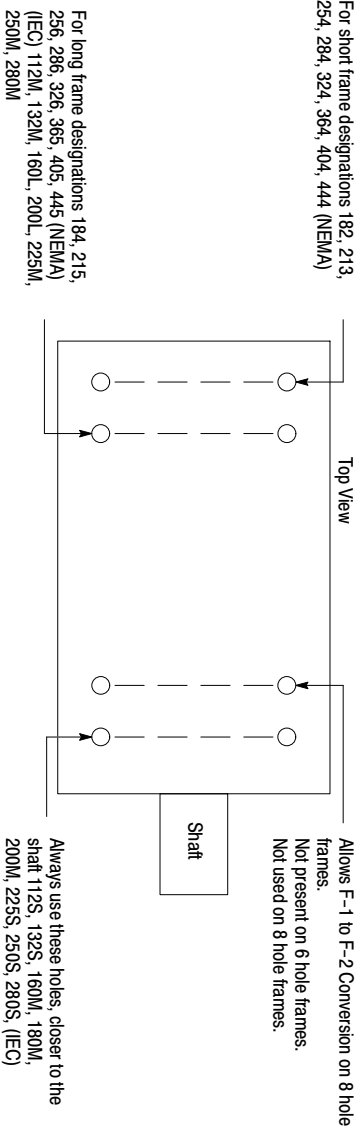

**Caution:** Do not lift the motor and its driven load by the motor lifting hardware. The motor lifting hardware is adequate for lifting only the motor. Disconnect the load (gears, pumps, compressors, or other driven equipment) from the motor shaft before lifting the motor.

In the case of assemblies on a common base, any lifting means provided on the motor should not be used to lift the assembly and base but, rather, the assembly should be lifted by a sling around the base or by other lifting means provided on the base. Assure lifting in the direction intended in the design of the lifting means. Likewise, precautions should be taken to prevent hazardous overloads due to deceleration, acceleration or shock forces.

**Alignment**  
Accurate alignment of the motor with the driven equipment is extremely important. The pulley, sprocket, or gear used in the drive should be located on the shaft as close to the shaft shoulder as possible. It is recommended to heat the pulley, sprocket, or gear before installing on the motor shaft. Forcibly driving a unit on the motor shaft will damage the bearings.

1. **Direct Coupling**  
For direct drive, use flexible couplings if possible. Consult the drive or equipment manufacturer for more information. Mechanical vibration and roughness during operation may indicate poor alignment. Use dial indicators to check alignment. The space between coupling hubs should be maintained as recommended by the coupling manufacturer.
2. **End-Play Adjustment**  
The axial position of the motor frame with respect to its load is also extremely important. The standard motor bearings are not designed for excessive external axial thrust loads. Improper adjustment will cause failure.
3. **Pulley Ratio**  
The best practice is to not exceed an 8:1 pulley ratio.
4. **Belt Drive**  
Align sheaves carefully to minimize belt wear and axial bearing loads (see End-Play Adjustment). Belt tension should be sufficient to prevent belt slippage at rated speed and load. However, belt slippage may occur during starting.

**Caution:** Do not over tension belts. Excess tension may damage the motor or driven equipment.

**Doweling & Bolting** After proper alignment is verified, dowel pins should be inserted through the motor feet into the foundation. This will maintain the correct motor position should motor removal be required.

- (Baldor•Reliance motors are designed for doweling.)
1. Drill dowel holes in diagonally opposite motor feet in the locations provided.
  2. Drill corresponding holes in the foundation.
  3. Ream all holes.
  4. Install proper fitting dowels.
  5. Mounting bolts must be carefully tightened to prevent changes in alignment.

Use a flat washer and lock washer under each nut or bolt head to hold the motor feet secure. Flanged nuts or bolts may be used as an alternative to washers.

**WARNING:** **Guards must be installed for rotating parts such as couplings, pulleys, external fans, and unused shaft extensions, should be permanently guarded to prevent accidental contact by personnel. Accidental contact with body parts or clothing can cause serious or fatal injury.**

**Guarding**

Guards must be installed for rotating parts such as couplings, pulleys, external fans, and unused shaft extensions. This is particularly important where the parts have surface irregularities such as keys, key ways or set screws. Some satisfactory methods of guarding are:

1. Covering the machine and associated rotating parts with structural or decorative parts of the driven equipment.
2. Providing covers for the rotating parts. Covers should be sufficiently rigid to maintain adequate guarding during normal service.

**Power Connection** Motor and control wiring, overload protection, disconnects, accessories and grounding should conform to the National Electrical Code and local codes and practices.

For ExnA hazardous location motors, it is a specific condition of use that all terminations in a conduit box be fully insulated. Flying leads must be insulated with two full wraps of electrical grade insulating tape or heat shrink tubing.

**Grounding**

In the USA consult the National Electrical Code, Article 430 for information on grounding of motors and generators, and Article 250 for general information on grounding. In making the ground connection, the installer should make certain that there is a solid and permanent metallic connection between the ground point, the motor or generator terminal housing, and the motor or generator frame. In non-USA locations consult the appropriate national or local code applicable.

Motors with resilient cushion rings usually must be provided with a bonding conductor across the resilient member. Some motors are supplied with the bonding conductor on the concealed side of the cushion ring to protect the bond from damage. Motors with bonded cushion rings should usually be grounded at the time of installation in accordance with the above recommendations for making ground connections. When motors with bonded cushion rings are used in multimotor installations employing group fusing or group protection, the bonding of the cushion ring should be checked to determine that it is adequate for the rating of the branch circuit over current protective device being used.

There are applications where grounding the exterior parts of a motor or generator may result in greater hazard by increasing the possibility of a person in the area simultaneously contacting ground and some other nearby live electrical parts of other ungrounded electrical equipment. In portable equipment it is difficult to be sure that a positive ground connection is maintained as the equipment is moved, and providing a grounding conductor may lead to a false sense of security.

Select a motor starter and over current protection suitable for this motor and its application. Consult motor starter application data as well as the National Electric Code and/or other applicable local codes. For motors installed in compliance with IEC requirements, the following minimum cross sectional area of the protective conductors should be used:

| Cross-sectional area of phase conductors, <i>S</i> | Minimum cross-sectional area of the corresponding protective conductor, <i>S<sub>p</sub></i> |
|--|--|
| mm <sup>2</sup>                                    | mm <sup>2</sup>  |
| <i>S</i> < 16                                      | <i>S</i>   |
| 16 < <i>S</i> ≤ 35                                 | 16   |
| <i>S</i> > 35                                      | 0.5 <i>S</i>   |

Equipotential bonding connection shall made using a conductor with a cross-sectional area of at least 4 mm<sup>2</sup>.

**Conduit Box** For ease of making connections, an oversize conduit box is provided. Most conduit boxes can be rotated 360° in 90° increments. Auxiliary conduit boxes are provided on some motors for accessories such as space heaters, RTD's etc.

**AC Power**

Motors with flying lead construction must be properly terminated and insulated. Connect the motor leads as shown on the connection diagram located on the name plate or inside the cover on the conduit box. Be sure the following guidelines are met:

1. AC power is within ±10% of rated voltage with rated frequency. (See motor name plate for ratings). **OR**
  2. AC power is within ±5% of rated frequency with rated voltage. **OR**
  3. A combined variation in voltage and frequency of ±10% (sum of absolute values) of rated values, provided the frequency variation does not exceed ±5% of rated frequency.
- Performance within these voltage and frequency variations are shown in Figure 2-4.

**Figure 2-3 Accessory Connections**



One heater is installed in each end of motor. Leads for each heater are labeled H1 & H2. (Like numbers should be tied together).

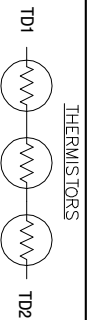

Three thermistors are installed in windings and tied in series. Leads are labeled TD1 & TD2.

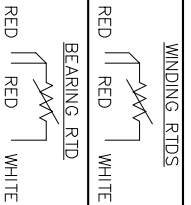

Winding RTDs are installed in windings (2) per phase. Each set of leads is labeled 1TD1, 1TD2, 1TD3, 2TD1, 2TD2, 2TD3 etc.

- \* One bearing RTD is installed in Drive endplate (PUEP), leads are labeled RTDDE;
- \* One bearing RTD is installed in Opposite Drive endplate (FREP), leads are labeled RTDODE;
- \* Note RTD may have 2-Red/1-White leads; or 2-White/1-Red Lead.

**Rotation**

All three phase motors are reversible. To reverse the direction of rotation, disconnect and lock out power and interchange any two of the three line leads for three phase motors. For single phase motors, check the connection diagram to determine if the motor is reversible and follow the connection instructions for lead numbers to be interchanged. Not all single phase motors are reversible.

Adjustable Frequency Power Inverters used to supply adjustable frequency power to induction motors produce wave forms with lower order harmonics with voltage spikes superimposed. Turn-to-turn, phase-to-phase, and ground insulation of stator windings are subject to the resulting dielectric stresses. Suitable precautions should be taken in the design of these drive systems to minimize the magnitude of these voltage spikes. Consult the drive instructions for maximum acceptable motor lead lengths, and proper grounding.

Note: Main power leads for CE Marked Motors may be marked U, V, W – for standard configurations. please consult connection diagrams.

### Connection Diagrams AC Motor Connection Diagram

IEC VERSUS NEMA LEAD MARKING  
EXAMPLE COMPARISONS OF IEC AND NEMA LEADING MARKINGS FOR COMMON CONNECTION TYPES ARE SHOWN BELOW.

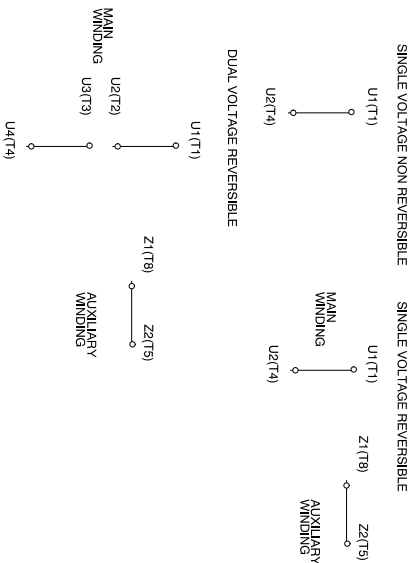

### AC Motor Connection Diagram

THREE PHASE  
FOR SINGLE WINDING 3 PHASE MOTORS, LEAD MARKINGS CAN BE DIRECTLY TRANSLATED FOR SINGLE LEAD MOTORS AS FOLLOWS:  
EQUIVALENTS FOR LEADS, FOR THESE MOTORS, THE LEAD MARKINGS ARE

U<sub>1</sub>=T1 U<sub>2</sub>=T4 U<sub>3</sub>=T7 U<sub>4</sub>=T10  
V<sub>1</sub>=T2 U<sub>2</sub>=T5 U<sub>3</sub>=T8 U<sub>4</sub>=T11  
W<sub>1</sub>=T3 U<sub>2</sub>=T6 U<sub>3</sub>=T9 U<sub>4</sub>=T12

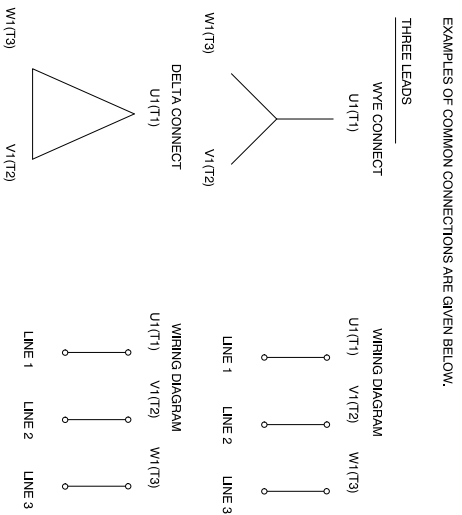

### AC Motor Connection Diagram

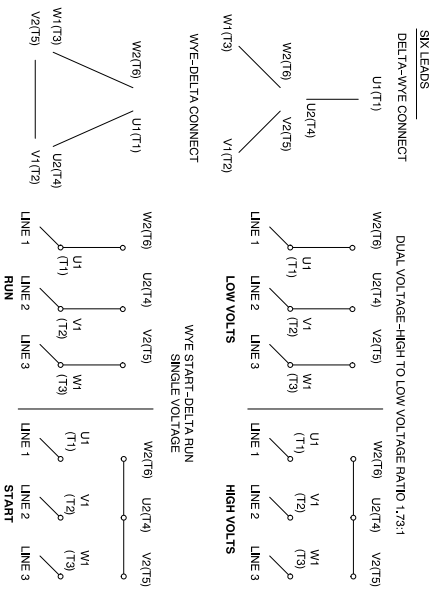

### AC Motor Connection Diagram

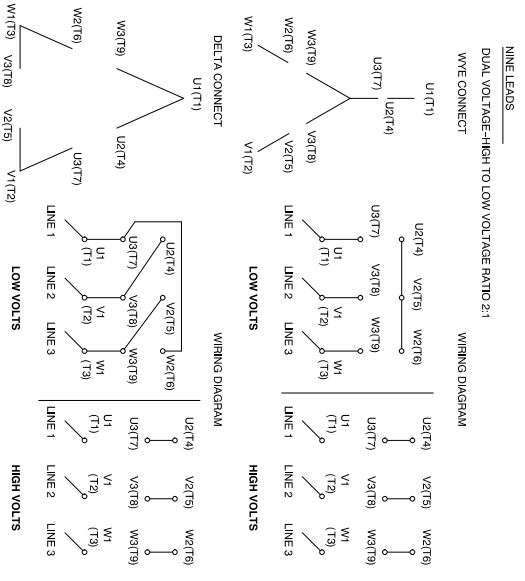

MN408

Installation & Operation 2-5

**Connection Diagrams Continued**  
**AC Motor Connection Diagram**

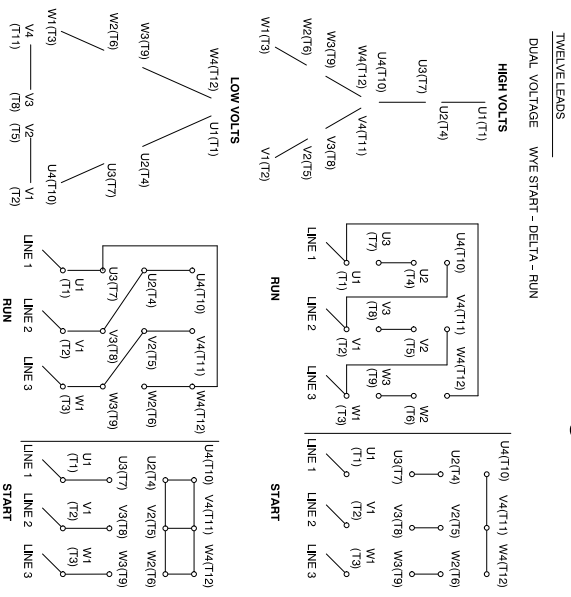

**AC Motor Connection Diagram**

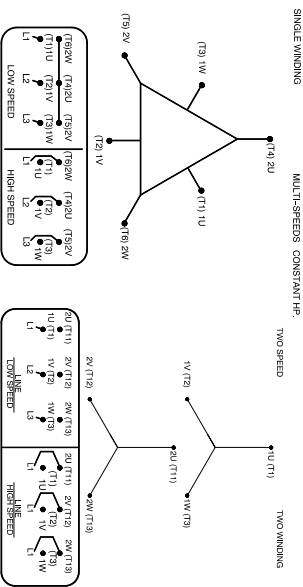

**DC Motor Connection Diagram**

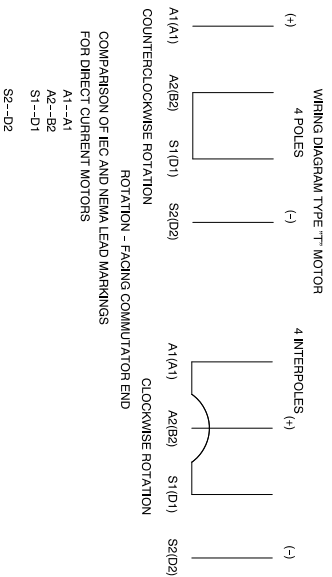

2-6 Installation & Operation

**AC Motor Connection Diagram**

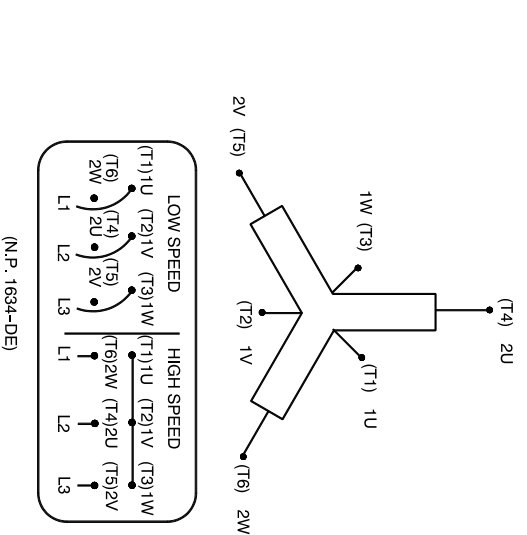

| MOTOR WINDING THERMOSTATS |                    | °C             |  |
|---------------------------|--------------------|----------------|--|
| CONTACTS                  | FIGURE NUMBER      |                |  |
| <b>CONTACT RATING</b>     |                    |                |  |
| VOLTS                     | CONTINUOUS AMPERES | INRUSH AMPERES |  |
| 110 - 120                 | 3.0                | 30             |  |
| 220 - 240                 | 1.5                | 15             |  |
| 440 - 480                 | 0.75               | 7.5            |  |
| 550 - 600                 | 0.60               | 6.0            |  |

| THERMOSTATS     |                 |
|-----------------|-----------------|
| NORMALLY CLOSED | NORMALLY OPEN   |
| <p>FIGURE 1</p> | <p>FIGURE 4</p> |
| <p>FIGURE 2</p> | <p>FIGURE 5</p> |
| <p>FIGURE 3</p> | <p>FIGURE 6</p> |

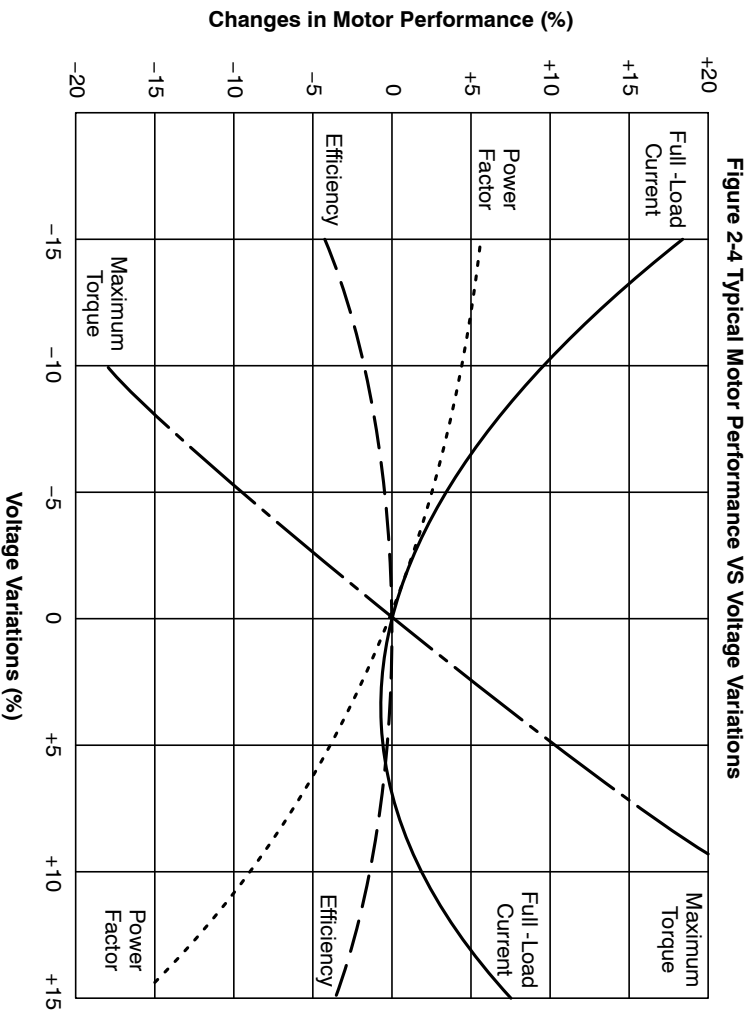

**Initial Lubrication** Baldor•Reliance motors are shipped from the factory with the bearings properly packed with grease and ready to operate. Where the unit has been subjected to extended storage (6 months or more) the bearings should be relubricated (greasable type) prior to starting. When motors are equipped for oil mist lubrication refer to the instruction manual for installation, operation, and maintenance of oil mist lubrication systems.

**First Time Start Up** Be sure that all power to motor and accessories is off. Be sure the motor shaft is disconnected from the load and will not cause mechanical rotation of the motor shaft.

1. Make sure that the mechanical installation is secure. All bolts and nuts are tightened etc.
2. If motor has been in storage or idle for some time, check winding insulation integrity.
3. Inspect all electrical connections for proper termination, clearance, mechanical strength and electrical continuity.
4. Be sure all shipping materials and braces (if used) are removed from motor shaft.
5. Manually rotate the motor shaft to ensure that it rotates freely.
6. Replace all panels and covers that were removed during installation.
7. Momentarily apply power and check the direction of rotation of the motor shaft.
8. If motor rotation is wrong, be sure power is off and change the motor lead connections. Verify rotation direction before you continue.
9. Start the motor and ensure operation is smooth without excessive vibration or noise. If so, run the motor for 1 hour with no load connected.
10. After 1 hour of operation, disconnect power and connect the load to the motor shaft. Verify all coupling guards and protective devices are installed. Ensure motor is properly ventilated.
11. If motor is totally enclosed fan-cooled or non-ventilated it is recommended that condensation drain plugs, if present, be removed. These are located in the lower portion of the end-shields. Totally enclosed fan-cooled "XT" motors are normally equipped with automatic drains which may be left in place as received.

---

**Coupled Start Up** This procedure assumes a coupled start up. Also, that the first time start up procedure was successful.

1. Check the coupling and ensure that all guards and protective devices are installed.
2. Check that the coupling is properly aligned and not binding.
3. The first coupled start up should be with no load. Apply power and verify that the load is not transmitting excessive vibration back to the motor through the coupling or the foundation. Vibration should be at an acceptable level.
4. Run for approximately 1 hour with the driven equipment in an unloaded condition.

The equipment can now be loaded and operated within specified limits. Do not exceed the name plate ratings for amperes for steady continuous loads.

**Jogging and Repeated Starts** Repeated starts and/or jogs of induction motors generally reduce the life of the motor winding insulation. A much greater amount of heat is produced by each acceleration or jog than by the same motor under full load. If it is necessary to repeatedly start or jog the motor, it is advisable to check the application with your local Baldor distributor or Baldor Service Center.

**Heating** - Duty rating and maximum ambient temperature are stated on the motor name plate. Do not exceed these values. If there is any question regarding safe operation, contact your local Baldor distributor or Baldor Service Center.

#### **Hazardous Locations**

Hazardous locations are those where there is a risk of ignition or explosion due to the presence of combustible gases, vapors, dust, fibers or flyings.

**Selection** Facilities requiring special equipment for hazardous locations are typically classified in accordance with local requirements. In the US market, guidance is provided by the National Electric Code. In international hazardous location areas, guidance for gas / vapor / mist classification is given in IEC60079-14, or for dust in IEC61241-14. This classification process lets the installer know what equipment is suitable for installation in that environment, and identifies what the maximum safe temperature or temperature class is required. It is the customer or users responsibility to determine the area classification and select proper equipment.

Areas are classified with respect to risk and exposure to the hazard. In the US market, areas are typically classified as follows Class, Division, Group and Temperature Class. In some newer installations in the US and in most international markets, areas are classified in Zones.

#### **Protection Concepts**

**Class I Division 1 / Zone 1 [Equipment Group I (mining) or II (surface), Equipment Protection Level (EPL) Gb, Mb ]**

Baldor offers a range of motors suitable for installation in a Division 1 or Zone 1 environment. These motors are known as explosion proof or flameproof. (Insert flameproof motor cut away drawing)  
Motors that are explosion proof or flameproof use specially machined flameproof joints between the end bell or bracket and the frame, as well as along the rotating shaft and at connection box covers and entries. The fit of these flameproof joints are designed to contain the combustion or quench the flame of an explosive gas atmosphere prior to it exiting the motor. These flameproof joints have lengths and widths selected and tested based on the gas group present in the atmosphere. Baldor•Reliance motors are typically designed to meet Class I (Division 1) Group C and D (explosion proof) or Ex d IIB (flameproof).

An application note regarding equipment applied in accordance with the US National Electric Code (NFPA 70-2008) – according to Article 500.8(C) Marking, sub clause (2) in the fine print note, it is noted that Equipment not marked to indicate a division is suitable for both Division 1 and Division 2 locations. These motors are not gas tight. To the contrary, this protection concept assumes that due to the normal heating and cooling cycle of motor operation that any gas present will be drawn into the motor. Since flameproof or explosion proof motors are designed to contain the combustion and extinguish any flame transmission, for this protection concept, only external surface temperatures are of concern. Thermal limiting devices such as thermostats, thermistors or RTDs may be provided on these motors to limit the external surface temperature during overload conditions.

If thermostats are provided as a condition of certification, it is the installer's responsibility to make sure that these devices are properly connected to a suitable switching device. The ATEX directive requires that motor shutdown on thermal trip be accomplished without an intermediate software command. Flameproof motors, internationally referred to as Ex d use a protection concept similar to that used in Class I Division 1 motors, with minor differences in the flameproof joints and cable entry designs. Flameproof and explosion proof motors are both type tested. Representative motors are connected to a reference gas and ignited in laboratory conditions to verify that the flame is not transmitted outside the motor enclosure and to determine the maximum internal pressure encountered.

Explosion proof and Flame proof motors shipped without a conduit box require use of a certified box of suitable dimensions and that is appropriate for the classification.

#### **Class I Division 2 / Zone 2 Ex nA, [Equipment Protection Level (EPL) Gc ]**

This protection concept relies on having no sources of ignition present such as arcing parts or hot surfaces. For this protection concept, internal temperatures as well as external temperatures are considered. In many cases, the internal temperatures are higher than the external temperatures and therefore become the limiting factor in determination of temperature code designation. In these applications, it is very important to use a motor that has been evaluated thermally for use with an inverter or converter, if variable speed operation is desired. Thermostats used for Class I Division 2 and Ex nA motors are used to protect the motor only. For motors using flying lead construction, it is important to use connection lugs and insulate with heat shrink tubing or a double wrap of insulation grade electrical tape to avoid the risk of spark or ignition.

#### **Class II Division 1 / Zone 21 [Equipment Group III, Equipment Protection Level (EPL) Db ]**

This area classification is one where the risk of ignitable concentrations of dust is present at all or some of the time. The protection concepts used for Class II Division 1 is similar to flameproof, except with additional dust exclusion paths designed for the rotating shaft. In the international designations, this concept is referred to as dust ignition proof or Ex tD. External surface temperature remains the limiting factor. Thermal limiting devices such as thermostats, thermistors or RTDs may be provided on these motors to limit the external surface temperature during overload conditions. If thermostats are provided as a condition of certification, it is the installer's responsibility to make sure that these devices are properly connected to a suitable switching device.

Note: In the North American area classification system, Class III exists for fibers and flyings.

In the IEC designation, both dusts and flyings are absorbed into Group III.

#### **Class II Division 2 / Zone 22 [Equipment Group III, Equipment Protection Level (EPL) Dc ]**

This area classification is one where the risk of exposure to ignitable concentrations of dust are not likely to occur under normal operating conditions and relies heavily on the housekeeping practices within the installation.

#### **Sine Wave Power Operation for Division 1 or 2 and Zone 1 or 2 and Zone 21 or 22 Hazardous Location.**

These motors are designed to operate at or below the maximum surface temperature (or T-Code) stated on the nameplate. Failure to operate the motor properly can cause this maximum surface temperature to be exceeded. If applied in a Division 1 or 2 / Zone 1 or 2 and Zone 21 or 22 environment, this excessive temperature may cause ignition of hazardous materials. Operating the motor at any of the following conditions can cause the marked surface temperature to be exceeded.

1. Motor load exceeding service factor nameplate value
2. Ambient temperatures above nameplate value
3. Voltages above or below nameplate value
4. Unbalanced voltages
5. Loss of proper ventilation
6. Altitude above 3300 feet / 1000 meters
7. Severe duty cycles of repeated starts
8. Motor stall
9. Motor reversing
10. Single phase operation of polyphase equipment
11. Variable frequency operation

#### **Variable Frequency Power Operation for Division 1 or 2 and Zone 1 or 2 and Zone 21 or 22**

**Hazardous Location** (motors with maximum surface temperature listed on the nameplate).

Only motors with nameplates marked for use on inverter (variable frequency) power, and labeled for specific hazardous areas may be used in those hazardous areas on inverter power. The motor is designed to operate at or below the maximum surface temperature (or T-Code) stated on the nameplate. Failure to operate the motor properly can cause this maximum surface temperature to be exceeded.

If applied in a Division 1 or 2 / Zone 1 or 2 and Zone 21 or 22 environment, this excessive temperature may cause ignition of hazardous materials. Operating the motor at any of the following conditions can cause the marked surface temperature to be exceeded.

1. Motor load exceeding service factor nameplate value
2. Ambient temperature above nameplate value
3. Voltage (at each operating frequency) above or below rated nameplate value
4. Unbalanced voltages
5. Loss of proper ventilation
6. Operation outside of the nameplate speed / frequency range
7. Altitudes above 3300 feet / 1000 meters
8. Single phase operation of polyphase equipment
9. Unstable current wave forms
10. Lower than name plate minimum carrier frequency

#### **Thermal Limiting**

Thermal limiting devices are temperature sensing control components installed inside the motor to limit the internal temperature of the motor frame by interrupting the circuit of the holding coil of the magnetic switch or contactor. They are required for most Division 1 and Zone 1 applications. For Division 2 or Zone 2 applications, motors should be selected that preclude running temperatures from exceeding the ignition temperatures for the designated hazardous material. In Division 2 or Zone 2 classified locations, thermal limiting devices should only be used for winding protection and not considered for limiting all internal motor temperatures to specific ignition temperatures.

#### **Equipotential Bonding and Shaft Current Reduction**

Larger motors (ie WP construction) may require proper bonding between motor enclosures and covers to avoid the risk of stray currents during start up. Fastening methods and bonding straps must not be modified. Bearing currents can exist in some motors for both line-fed and inverter-fed applications. Larger line-fed motors may require at least one insulated bearing to prevent a flow of current through the bearings. Do not defeat such insulation whether the motor is line-fed or inverter-fed applications. Inverter-fed motors may require additional bearing insulation or even a shaft brush. Do not defeat such features. When the motor and the coupled load are not on a common conductive baseplate, it may also be necessary to electrically bond together the stationary parts of the motor and the coupled equipment.

#### **Repair of Motors used in Hazardous Locations**

Repair of hazardous certified motors requires additional information, skill, and care. It is the customer's responsibility to select service shops with proper qualifications to repair hazardous location motors.

Contact the manufacturer for additional repair details. Use only original manufacturer's parts.

#### **Repair of Explosion Proof or Flame Proof Motors Class I Division 1 and Zone 1**

In the North American market, recertification programs are offered by Underwriters Laboratories and Canadian Standards Association which allow authorized service shops to mark the rebuilt motors as certified. In the international markets using IEC based requirements, repair should be undertaken only after consulting IEC60079-19 Explosive Atmospheres-Part 19 Equipment repair, overhaul and reclamation. If use of a certified repair facility is desired, consult the IECEx Repair Scheme at

[http://www.iecex.com/service\\_facilities.htm](http://www.iecex.com/service_facilities.htm)

Explosion proof and flameproof motors achieve their safety based on the mechanical construction – flameproof joints and bearing clearance, and the electrical design including any thermal limiting devices. If it is necessary to repair a flameproof or explosion proof motor, it is critical that the mechanical flameproof joints be maintained. Consult Baldor Electric Company for flameproof joint construction details. Use only Baldor•Reliance supplied parts. Baldor does not recommend reclamation of parts. Since this protection method also relies on temperature being maintained, make sure that any rewinding uses the original electrical designs, including any thermal protection that may be present.

#### **Repair of Dust Ignition Proof Motors – Class II Division 1 and 2, Zone 21 and 22.**

For Dust Ignition Proof, proper sealing is required. Do not modify the motor construction to add any additional opening, and ensure that proper sealing is maintained in the connection box and at the shaft seal. Since this protection method also relies on temperature being maintained, make sure that any rewinding uses the original electrical designs, including any thermal protection that may be present

#### **Repair of Class I Division 2 and Zone 2 motors**

For Division 2 and Zone 2, the internal and external temperatures are of concern. Since this protection method also relies on temperature being maintained, make sure that any rewinding uses the original electrical designs, including any thermal protection that may be present. Use only Baldor replacement thermostats, if provided.

## Section 3 Maintenance & Troubleshooting

**WARNING:** UL and EX Listed motors must only be serviced by UL or EX Approved Authorized Baldor Service Centers if these motors are to be returned to a hazardous and/or explosive atmosphere.

**General Inspection** Inspect the motor at regular intervals, approximately every 500 hours of operation or every 3 months, whichever occurs first. Keep the motor clean and the ventilation openings clear. The following steps should be performed at each inspection:

**WARNING:** Do not touch electrical connections before you first ensure that power has been disconnected. Electrical shock can cause serious or fatal injury. Only qualified personnel should attempt the installation, operation and maintenance of this equipment.

1. Check that the motor is clean. Check that the interior and exterior of the motor is free of dirt, oil, grease, water, etc. Oily vapor, paper pulp, textile lint, etc. can accumulate and block motor ventilation. If the motor is not properly ventilated, overheating can occur and cause early motor failure.
2. Perform a dielectric with stand test periodically to ensure that the integrity of the winding insulation has been maintained. Record the readings. Immediately investigate any significant decrease in insulation resistance.
3. Check all electrical connectors to be sure that they are tight.

**Relubrication & Bearings** Bearing grease will lose its lubricating ability over time, not suddenly. The lubricating ability of a grease (over time) depends primarily on the type of grease, the size of the bearing, the speed at which the bearing operates and the severity of the operating conditions. Good results can be obtained if the following recommendations are used in your maintenance program.

**Type of Grease** A high grade ball or roller bearing grease should be used. Recommended grease for standard service conditions is **Polyrex EM (Exxon Mobil)**. Do not mix greases unless compatibility has been checked and verified.

### Ball Bearing Motors

|   |  |
|---|--|
| Operating Temperature -25°C (-15°F) to 50°C (120°F) | POLYREX EM (Standard on Baldor motors) |
| EXXON   | UNIREX N2                              |
| EXXON   | BEACON 325                             |
| CHEVRON OIL   | SRI NO. 2 (Compatible with Polyrex EM) |
| CHEVRON OIL   | BLACK PEARL                            |
| TEXACO, INC.  | PREMIUM RB                             |
| TEXACO, INC.  | POLYSTAR                               |
| AMOCO   | RYKON # 2                              |
| PENNZOIL  | PENNZLUBE EM-2                         |
| DARMEK  | DARMEK 707                             |
| DARMEK  | DARMEK 711                             |
| PETRO-CANADA  | PEERLESS LLG                           |
| SHELL OIL   | DOLLUM BRB                             |

|  |  |
|--|--|
| Minimum Starting Temperature -60°C (-76°F) |  |
| SHELL OIL CO.                              | AEROSHELL 7 (Standard on Baldor motors)          |
| MOBIL                                      | MOBIL 28   |
| MOBIL                                      | MOBILITH SHC 100 (Low Temperature - Arctic Duty) |

### Roller Bearing Motors

|   |  |
|---|--|
| Operating Temperature -25°C (-15°F) to 50°C (120°F) | PREMIUM RB                                   |
| TEXACO, INC.  | MOBILITH SHC 220 (Standard on Baldor motors) |
| MOBIL   | BLACK PEARL                                  |
| CHEVRON OIL   |  |

**Relubrication Intervals** Recommended relubrication intervals are shown in Table 3-2. It is important to realize that the recommended intervals of Table 3-2 are based on average use.

Refer to additional information contained in Tables 3-3, 3-4 and 3-5.

**Table 3-2 Relubrication Intervals \***

| NEMA / (IEC) Frame Size     | Rated Speed - RPM |           |             |            |            |            |
|-----------------------------|-------------------|-----------|-------------|------------|------------|------------|
|                             | 10000             | 6000      | 3600        | 1800       | 1200       | 900        |
| Up to 210 Incl. (132)       | **                | 2700 Hrs. | 5500 Hrs.   | 12000 Hrs. | 18000 Hrs. | 22000 Hrs. |
| Over 210 to 280 Incl. (180) |                   | **        | 3600 Hrs.   | 9500 Hrs.  | 15000 Hrs. | 18000 Hrs. |
| Over 280 to 360 Incl. (225) |                   | **        | * 2200 Hrs. | 7400 Hrs.  | 12000 Hrs. | 15000 Hrs. |
| Over 360 to 449 Incl. (315) |                   | **        | *2200 Hrs.  | 3500 Hrs.  | 7400 Hrs.  | 10500 Hrs. |

\* Relubrication intervals are for ball bearings.

For vertically mounted motors and roller bearings, divide the relubrication interval by 2.

\*\* For motors operating at speeds greater than 3600 RPM, contact Baldor for relubrication recommendations.

**Table 3-3 Service Conditions**

| Severity of Service | Hours per day of Operation | Ambient Temperature Maximum   | Atmospheric Contamination                                       |
|---------------------|----------------------------|-------------------------------|---|
| Standard            | 8                          | 40° C                         | Clean, Little Corrosion   |
| Severe              | 16 Plus                    | 50° C                         | Moderate dirt, Corrosion  |
| Extreme             | 16 Plus                    | >50° C* or Class H Insulation | Severe dirt, Abrasive dust, Corrosion, Heavy Shock or Vibration |
| Low Temperature     |                            | <-29° C **                    |   |

\* Special high temperature grease is recommended (Dow Corning DC44). Note that Dow Corning DC44 grease does not mix with other grease types. Thoroughly clean bearing & cavity before adding grease.

\*\* Special low temperature grease is recommended (Aeroshell 7).

**Table 3-4 Relubrication Interval Multiplier**

| Severity of Service | Multiplier |
|---------------------|------------|
| Standard            | 1.0        |
| Severe              | 0.5        |
| Extreme             | 0.1        |
| Low Temperature     | 1.0        |

Some motor designs use different bearings on each motor end. This is normally indicated on the motor nameplate. In this case, the larger bearing is installed on the motor Drive endplate. For best relubrication results, only use the appropriate amount of grease for each bearing size (not the same for both).

**Table 3-5 Bearings Sizes and Types**

| Frame Size<br>NEMA (IEC)  | Bearing | Bearing Description<br>(These are the "Large" bearings (Shaft End) in each frame size) |                              |          |
|---------------------------|---------|--|------------------------------|----------|
|                           |         | Weight of Grease to add *  | Volume of grease to be added |          |
|                           |         | oz (Grams)   | in <sup>3</sup>              | teaspoon |
| 56 to 140 (90)            | 6203    | 0.08 (2.4)   | 0.15                         | 0.5      |
| 140 (90)                  | 6205    | 0.15 (3.9)   | 0.2                          | 0.8      |
| 180 (100-112)             | 6206    | 0.19 (5.0)   | 0.3                          | 1.0      |
| 210 (132)                 | 6307    | 0.30 (8.4)   | 0.6                          | 2.0      |
| 250 (160)                 | 6309    | 0.47 (12.5)  | 0.7                          | 2.5      |
| 280 (180)                 | 6311    | 0.61 (17)  | 1.2                          | 3.9      |
| 320 (200)                 | 6312    | 0.76 (20.1)  | 1.2                          | 4.0      |
| 360 (225)                 | 6313    | 0.81 (23)  | 1.5                          | 5.2      |
| 400 (250)                 | 6316    | 1.25 (33)  | 2.0                          | 6.6      |
| 440 (280)                 | 6319    | 2.12 (60)  | 4.1                          | 13.4     |
| 5000 to 5800 (315-450)    | 6328    | 4.70 (130)   | 9.2                          | 30.0     |
| 5000 to 5800 (315-450)    | NU328   | 4.70 (130)   | 9.2                          | 30.0     |
| 360 to 449 (225-280)      | NU319   | 2.12 (60)  | 4.1                          | 13.4     |
| <b>AC Induction Servo</b> |         |  |                              |          |
| 76 Frame 180 (112)        | 6207    | 0.22 (6.1)   | 0.44                         | 1.4      |
| 77 Frame 210 (132)        | 6210    | 0.32 (9.0)   | 0.64                         | 2.1      |
| 80 Frame 250(160)         | 6213    | 0.49 (14.0)  | 0.99                         | 3.3      |

\* Weight in grams = .005 DB of grease to be added  
 Note: Not all bearing sizes are listed.  
 For intermediate bearing sizes, use the grease volume for the next larger size bearing.

**Caution:** To avoid damage to motor bearings, grease must be kept free of dirt. For an extremely dirty environment, contact your Baldor distributor or an authorized Baldor Service Center for additional information.

**Relubrication Procedure** Be sure that the grease you are adding to the motor is compatible with the grease already in the motor. Consult your Baldor distributor or an authorized service center if a grease other than the recommended type is to be used.

**Caution:** Do not over-lubricate motor as this may cause premature bearing failure.

**With Grease Outlet Plug**

1. With the motor stopped, clean all grease fittings with a clean cloth.
2. Remove grease outlet plug.

**Caution:** Over-lubricating can cause excessive bearing temperatures, premature lubrication breakdown and bearing failure.

3. Add the recommended amount of grease.
4. Operate the motor for 15 minutes with grease plug removed. This allows excess grease to purge.
5. Re-install grease outlet plug.

**Without Grease Provisions**

**Note:** Only a Baldor authorized and UL or CSA certified service center can disassemble a UL/CSA listed explosion proof motor to maintain it's UL/CSA listing.

1. Disassemble the motor.
2. Add recommended amount of grease to bearing and bearing cavity. (Bearing should be about 1/3 full of grease and outboard bearing cavity should be about 1/2 full of grease.)
3. Assemble the motor.

**Sample Relubrication Determination**

Assume - NEMA 286T (IEC 180), 1750 RPM motor driving an exhaust fan in an ambient temperature of 43° C and the atmosphere is moderately corrosive.

1. Table 3-2 list 9500 hours for standard conditions.
  2. Table 3-3 classifies severity of service as "Severe".
  3. Table 3-5 shows that 1.2 in<sup>3</sup> or 3.9 teaspoon of grease is to be added.
- Note: Smaller bearings in size category may require reduced amounts of grease.

**Table 3-6 Troubleshooting Chart**

| <b>Symptom</b>       | <b>Possible Causes</b>  | <b>Possible Solutions</b>  |
|----------------------|---|--|
| Motor will not start | Usually caused by line trouble, such as, single phasing at the starter. | Check source of power. Check overloads, fuses, controls, etc.  |
| Excessive humming    | High Voltage.   | Check input line connections.  |
|                      | Eccentric air gap.  | Have motor serviced at local Baldor service center.  |
| Motor Over Heating   | Overload. Compare actual amps (measured) with nameplate rating.         | Locate and remove source of excessive friction in motor or load.   |
|                      | Single Phasing.   | Reduce load or replace with motor of greater capacity. Check current at all phases (should be approximately equal) to isolate and correct the problem.       |
|                      | Improper ventilation.   | Check external cooling fan to be sure air is moving properly across cooling fins.  |
|                      | Unbalanced voltage.   | Excessive dirt build-up on motor. Clean motor.   |
|                      | Rotor rubbing on stator.  | Check voltage at all phases (should be approximately equal) to isolate and correct the problem.  |
|                      | Over voltage or under voltage.  | Check air gap clearance and bearings.  |
|                      | Open stator winding.  | Tighten "Thru Bolts".  |
|                      | Grounded winding.   | Check input voltage at each phase to motor.  |
|                      | Improper connections.   | Check stator resistance at all three phases for balance.   |
|                      |   | Perform dielectric test and repair as required.  |
| Bearing Over Heating | Misalignment.   | Inspect all electrical connections for proper termination, clearance, mechanical strength and electrical continuity. Refer to motor lead connection diagram. |
|                      | Excessive belt tension.   | Check and align motor and driven equipment.  |
|                      | Excessive end thrust.   | Reduce belt tension to proper point for load.  |
|                      | Excessive grease in bearing.  | Reduce the end thrust from driven machine.   |
|                      | Insufficient grease in bearing.   | Remove grease until cavity is approximately 3/4 filled.  |
|                      | Dirt in bearing.  | Add grease until cavity is approximately 3/4 filled.   |
| Vibration            | Misalignment.   | Clean bearing cavity and bearing. Repack with correct grease until cavity is approximately 3/4 filled.   |
|                      | Rubbing between rotating parts and stationary parts.                    | Check and align motor and driven equipment.  |
|                      | Rotor out of balance.   | Isolate and eliminate cause of rubbing.  |
|                      | Resonance.  | Have rotor balance checked are repaired at your Baldor Service Center.   |
| Noise                | Foreign material in air gap or ventilation openings.                    | Tune system or contact your Baldor Service Center for assistance.  |
| Growling or whining  | Bad bearing.  | Remove rotor and foreign material. Reinstall rotor. Check insulation integrity. Clean ventilation openings.  |
|                      |   | Replace bearing. Clean all grease from cavity and new bearing. Repack with correct grease until cavity is approximately 3/4 filled.                          |

MN408

Maintenance & Troubleshooting 3-5

**Suggested bearing and winding RTD setting guidelines for Non-Hazardous Locations ONLY**

Most large frame AC Baldor motors with a 1.15 service factor are designed to operate below a Class B (80°C) temperature rise at rated load and are built with a Class H winding insulation system. Based on this low temperature rise, RTD (Resistance Temperature Detectors) settings for Class B rise should be used as a starting point. Some motors with 1.0 service factor have Class F temperature rise.

The following tables show the suggested alarm and trip settings for RTDs. Proper bearing and winding RTD alarm and trip settings should be selected based on these tables unless otherwise specified for specific applications.

If the driven load is found to operate well below the initial temperature settings under normal conditions, the alarm and trip settings may be reduced so that an abnormal machine load will be identified.

The temperature limits are based on the installation of the winding RTDs imbedded in the winding as specified by NEMA. Bearing RTDs should be installed so they are in contact with the outer race on ball or roller bearings or in direct contact with the sleeve bearing shell.

**Winding RTDs - Temperature Limit In °C (40°C Maximum Ambient)**

| Motor Load              | Class B Temp Rise ≤ 80°C<br>(Typical Design) |      | Class F Temp Rise ≤ 105°C |      | Class H Temp Rise ≤ 125°C |      |
|-------------------------|--|------|---------------------------|------|---------------------------|------|
|                         | Alarm  | Trip | Alarm                     | Trip | Alarm                     | Trip |
| ≤ Rated Load            | 130  | 140  | 155                       | 165  | 175                       | 185  |
| Rated Load to 1.15 S.F. | 140  | 150  | 160                       | 165  | 180                       | 185  |

Note: • Winding RTDs are factory production installed, not from Mod-Express.  
• When Class H temperatures are used, consider bearing temperatures and relubrication requirements.

**Bearing RTDs - Temperature Limit In °C (40°C Maximum Ambient)**

| Bearing Type<br>Oil or Grease | Anti-Friction |      | Sleeve |      |
|-------------------------------|---------------|------|--------|------|
|                               | Alarm         | Trip | Alarm  | Trip |
| Standard*                     | 95            | 100  | 85     | 95   |
| High Temperature**            | 110           | 115  | 105    | 110  |

Note: \* Bearing temperature limits are for standard design motors operating at Class B temperature rise.

\*\* High temperature lubricants include some special synthetic oils and greases.

Greases that may be substituted that are compatible with Polyrex EM (but considered as "standard" lubricants) include the following:

- Texaco Polystar
- Mobilith SHC-100
- Darnex 707
- Rykon Premium #2
- Pennzoil Pennzube EM-2
- Petro-Canada Peerless LLG
- Chevron SRI #2
- Chevron Black Pearl

See the motor nameplate for replacement grease or oil recommendation.  
Contact Baldor application engineering for special lubricants or further clarifications.

**Baldor District Offices Baldor District Offices**

- UNITED STATES**
- ARIZONA**  
6880 FLORISSA  
PHOENIX, AZ 85040  
PHONE: 602-994-0700  
FAX: 602-994-0700
- ARKANSAS**  
1001 COLLIERIE AVE  
CLARKSVILLE, AR 72830  
PHONE: 479-794-9108  
FAX: 479-794-9205
- CALIFORNIA**  
6680 FLOTTILLA  
COMMERCE, CA 90040  
PHONE: 323-724-6771  
FAX: 323-721-5859
- HAWAII**  
2108 FORDS STREET  
HONOLULU, HI 96819  
PHONE: 510-785-9910  
FAX: 510-785-9910
- COLORADO**  
3855 FOREST STREET  
DENVER, CO 80207  
PHONE: 303-623-0127  
FAX: 303-585-5172
- CONNECTICUT**  
3905 ELST 11TH AVENUE  
TAMPA, FL 33605  
PHONE: 813-247-2984  
FAX: 813-247-2984
- GEORGIA**  
62 TECHNOLOGY DR  
ALPHARETTA, GA 30005  
PHONE: 770-472-8300  
FAX: 770-772-7200
- ILLINOIS**  
4 SAMLINGS COURT  
BOLINGBROOK, IL 60440  
PHONE: 630-295-4400  
FAX: 630-228-9420
- INDIANA**  
5525 W. WINNESOTA STREET  
INDIANAPOLIS, IN 46241  
PHONE: 317-246-5100  
FAX: 317-246-5110
- IOWA**  
DES MONES  
DES MONES, IA 50316  
PHONE: 515-263-8829  
FAX: 515-263-8515
- MARYLAND**  
6680 SANTA BARBARA RD.  
SUITE 22/24  
ELKRIEDE, MD 21075  
PHONE: 410-519-2135  
FAX: 410-519-2977
- MASSACHUSETTS**  
BOSTON  
6 PULMAN STREET  
WORCESTER, MA 01606  
PHONE: 508-854-0708  
FAX: 508-854-0291
- MICHIGAN**  
5993 ProgressShine  
STERLING HEIGHTS, MI 48312  
PHONE: 586-978-9800  
FAX: 586-978-9999
- MINNESOTA**  
21801 14TH AVE. NORTH  
ROGERS, MN 55374  
PHONE: 763-428-3633  
FAX: 763-428-4551
- MISSOURI**  
422 INDUSTRIAL DRIVE  
ST. LOUIS, MO 63043  
PHONE: 314-291-9910  
FAX: 314-291-7690
- KANSAS CITY**  
1501 BEDFORD AVENUE  
NORTH KANSAS CITY, MO 64116  
PHONE: 816-987-0272  
FAX: 816-981-2135
- NEW YORK**  
ONE ELLIS DRIVE  
ALBURN, NY 13021  
PHONE: 315-565-3403  
FAX: 315-543-9823
- NORTH CAROLINA**  
629 RICHMOND ROAD  
CHARLOTTE, NC 28203  
PHONE: 336-272-5104  
FAX: 336-273-6228
- OHIO**  
2829 CRESCENTVILLE ROAD  
WEST CHESTER, OH 45398  
PHONE: 513-771-2800  
FAX: 513-771-2819
- CLEVELAND**  
8609 FREEMAN DRIVE  
MACEDONIA, OH 44065  
PHONE: 330-488-4777  
FAX: 330-488-4778
- OKLAHOMA**  
1710 S. Baden, Suite 140  
TULSA, OK 74104  
PHONE: 918-365-8320  
FAX: 918-365-8338
- OREGON**  
20383 SW AVERY COURT  
TUALATIN, OR 97062  
PHONE: 503-961-9010  
FAX: 503-961-9012
- PENNSYLVANIA**  
1005 THOMAS BUSCH  
PENNSAUKEN, NJ 08110  
PHONE: 856-661-1442  
FAX: 856-663-6363
- PITTSBURGH**  
159 PROMINENCE DRIVE  
NEW KENSINGTON, PA 15088  
PHONE: 724-888-0092  
FAX: 724-888-0094
- TEXAS**  
4000 WINCHESTER ROAD  
MEMPHIS, TN 38118  
PHONE: 901-585-2020  
FAX: 901-585-3914
- UTAH**  
2220 SOUTH MAIN STREET  
SALT LAKE CITY, UT 84115  
PHONE: 801-632-0177  
FAX: 801-632-8911
- WISCONSIN**  
2725 SOUTH 163RD STREET  
NEW BERLIN, WI 53151  
PHONE: 262-784-6940  
FAX: 262-784-1215
- INTERNATIONAL SALES**  
PORT SMITH, AR  
PORT SMITH, AR 72902  
PHONE: 479-646-4711  
FAX: 479-648-5895
- CANADA**
- EDMONTON, ALBERTA**  
4033 92 STREET  
EDMONTON, ALBERTA T6E 6R8  
PHONE: 780-424-4900  
FAX: 780-424-2800
- TORONTO, ONTARIO**  
2750 CONVENTY ROAD  
OAKVILLE, ONTARIO L6H 8R1  
PHONE: 905-829-3301  
FAX: 905-829-3302
- MONTREAL, QUEBEC**  
5155, J.A. Bonnierier  
St-Hubert(Quebec) Canada  
PHONE: 514-633-2711  
FAX: 514-633-8639
- VANCOUVER, BRITISH COLUMBIA**  
1538 KEBEL WAY  
PORT COULTLAM, BC V3C 9M6  
PHONE: 604-421-2822  
FAX: 604-421-1111
- WINNIPEG, MANITOBA**  
54 PRINCESS STREET  
WINNIPEG, MANITOBA R3B 1K2  
PHONE: 204-942-5205  
FAX: 204-956-4251
- AUSTRALIA**  
UNIT 3, 6 STANTON ROAD  
SEVEN HILLS, NSW 2147,  
AUSTRALIA  
PHONE: (61) 29 9674 645  
FAX: (61) 29 9727 045
- UNIT 8, KELLETT'S ROAD  
ROOVELLE, VICTORIA, 3178  
AUSTRALIA  
PHONE: (61) (3) 9753 4385  
FAX: (61) (3) 9753 4386**
- ESALVADOR**  
RESIDENCIAL PUNARES DE SUZUA  
POL. 1974  
SAN SALVADOR,  
EL SALVADOR  
PHONE: +503 2288-1519  
FAX: +503 2288-1518
- CHILE**  
LustThayer/Ojeda186,  
d402 - Providencia  
Santiago, Chile  
Phone: +56 2 816 8900  
FAX: +56 2 816 8900
- CHINA**  
ShengSheng and  
ShengSheng/STRY ZONE  
Shanghai/201613, China  
PHONE: +86 21 5760 5335  
FAX: +86 21 5760 5338
- GERMANY**  
DRESELSTRASSE 22  
D-85651 KIRCHHEIM  
MUNICH, GERMANY  
PHONE: +49 89 89 50 9492  
FAX: +49 89 89 50 9492
- INDIA**  
14, COMMERCIAL AVENUE  
MAHAGANESH COLONY  
PAUD ROAD  
PUNE - 411038  
MAHARASHTRA, INDIA  
PHONE: +91 20 28 45 27 17/18  
FAX: +91 20 28 45 27 19
- ITALY**  
BaldorSR AG  
SUCCURSALE DI Mendisio  
Vadorenno, 20A  
CH-8930 Mendisio  
Switzerland  
Phone: 0041 91 640 99 50  
FAX: 0041 91 630 28 33
- JAPAN**  
2-21-1 TSUBUYA-CHO,  
KANGAWA-KU  
YOKOHAMA, 221-0835, JAPAN  
PHONE: 81-45-412-4905  
FAX: 81-45-412-4507
- MEXICO**  
LEON, Guanajuato  
Km. 2.0 BLVD. AEROPUERTO  
LEON 37365, GUANAJUATO,  
MEXICO  
PHONE: +52 477 761 2030  
FAX: +52 477 761 2010
- MIDDLE EAST & NORTH AFRICA**  
VSE INTERNATIONAL CORP  
P. O. BOX 5618  
BULFALO GROVE, IL 60089-5618  
(USA) (630) 581-5847  
FAX: (630) 581-5807
- PANAMA**  
MIE RICARDO J. ALFARO  
EDIFICIO SIM TOWERS MALL  
PIRÓ 2, LOCAL 56  
CiudadPanama, Panama  
PHONE: +507 238-5155  
FAX: +507 238-0591
- SINGAPORE**  
18/KA BUKIT ROAD 3, #02/09  
TRADING CENTRE SINGAPORE  
CENTRE SINGAPORE 19979  
PHONE: (65) 6744 2272  
FAX: (65) 6747 1708
- SWITZERLAND**  
POSTFACH 73  
SCHUTZENSTRASSE 89  
CH-8245 FELDENTHAL  
SWITZERLAND  
PHONE: +41 52 647 4700  
FAX: +41 52 639 2394
- TAIWAN**  
F. No.78 Wenshan1stStreet,  
NantunDistrict,  
TainanCity/608  
Taiwan R.O.C.  
PHONE: (886) 4 239 4235  
FAX: (886) 4 239 0463
- UNITED KINGDOM**  
6 BRISTOL DISTRIBUTION PARK  
HAWKEY DRIVE  
BRISTOL BS32 0BF U.K.  
PHONE: +44 1454 880000  
FAX: +44 1454 889001
- VENEZUELA**  
Av. Troma, Chaguallago, Urb.  
Caracas, 1070  
Venezuela  
Phone: +58 212 272 7343  
mobile: +58 414 114 8623



**BALDOR ELECTRIC COMPANY**  
World Headquarters  
P.O. Box 2400 Fort Smith, AR 72901-2400  
(479) 646-4711 Fax (479) 648-5792  
[www.baldor.com](http://www.baldor.com)

© 2009 Baldor Electric Company  
MN408

All rights reserved. Printed in USA  
3/09

## AC & DC Motor Installation & Maintenance

**Safety Notice** Be sure to read and understand all of the Safety Notice statements in MN408. A copy is available at:  
[http://www.baldor.com/support/literature\\_load.asp?ManNumber=MN408](http://www.baldor.com/support/literature_load.asp?ManNumber=MN408)

### ACCEPTANCE

Thoroughly inspect this equipment before accepting shipment from the transportation company. If any damage or shortage is discovered do not accept until noted on the freight bill. Report all damage to the freight carrier.

### SAFETY

Eye bolts, lifting lugs or lifting openings, if provided, are intended only for lifting the motor and motor mounted standard accessories not exceeding, in total 30% of the motor weight. These lifting provisions should never be used when lifting or handling the motor and driven equipment. Eye bolt lifting capacity rating is based on a lifting alignment coincident with eye bolt center line. Eye bolt capacity reduces as deviation from this alignment is increased. Be sure eye bolts are tight and prevented from turning before lifting.

### INSTALLATION OUTSIDE THE USA:

Refer to MN408 and MNT 383 for Compliance with European Directives. Copies are available at:

[http://www.baldor.com/support/literature\\_load.asp](http://www.baldor.com/support/literature_load.asp)

### MOTOR ENCLOSURE

ODP, **Open drip proof** motors are intended for use in clean, dry locations with adequate supply of cooling air. These motors should not be used in the presence of flammable or combustible materials. Open motors can emit flame and/or molten metal in the event of insulation failure.

TEFC, **totally enclosed** motors are intended for use where moisture, dirt and/or corrosive materials are present in indoor and outdoor locations.

**Explosion protected** motors, as indicated by a Nationally Recognized Testing Laboratory Certification mark and marking with Class, Division and Temperature Code are intended for installation in hazardous locations as described in Article 500 of the NEC. Refer to MN408 for more details.

### MOUNTING

**Foot mounted** machines should be mounted to a rigid foundation to prevent excessive vibration. Shimms may be used if location is uneven.

**Flange mounted** machines should be properly seated and aligned. Note: If improper rotation direction is detrimental to the load, check rotation direction prior to coupling the load to the motor shaft.

**For V-belt drive**, mount the sheave pulley close to the motor housing. Allow clearance for end to end movement of the motor shaft. Do not overtighten belts as this may cause premature bearing failure or shaft breakage.

**Direct coupled** machines should be carefully aligned and the shaft should rotate freely without binding.

### GENERAL

The user must select a motor starter and overcurrent protection suitable for this motor and its application. Consult motor starter application data as well as the National Electric Code and/or applicable local codes. Special motors for use by United States Government including special specifications, master plans, etc. refer to the applicable master plans and specifications involved.

On motors received from the factory with the shaft blocked, remove blocking before operating the motor. If motor is to be reshipped alone or installed to another piece of equipment, the shaft block must be installed to prevent axial movement and prevent brinnelling of the bearings during shipment.

### TESTING

If the motor has been in storage for an extensive period or has been subjected to adverse moisture conditions, check the motor insulation resistance with a meg ohm meter. Depending on storage conditions it may be necessary to regrease or change rusted bearings. Contact Baldor District Office if resistance is less than 5 meg ohms.

### WARNING: Do not touch electrical connections before

**you first ensure that power has been disconnected. Electrical shock can cause serious or fatal injury.**

**WARNING: Be sure the system is properly grounded before applying power. Electrical shock can cause serious or fatal injury.**

### INSTALLATION

This motor must be installed in accordance with National Electric Code, NEMA MG-2, IEC standards and local codes.

### WIRING

Connect the motor as shown in the connection diagrams. If this motor is installed as part of a motor control drive system, connect and protect the motor according to the control manufacturers diagrams. Refer to MN408 for additional details on lead marking. The wiring, fusing and grounding must comply with the National Electrical Code or IEC and local codes. When the motor is connected to the load for proper direction of rotation and started, it should start quickly and run smoothly. If not, stop the motor immediately and determine the cause. Possible causes are: low voltage at the motor, motor connections are not correct or the load is too heavy. Check the motor current after a few minutes of operation and compare the measured current with the nameplate rating.

### GROUNDING

Ground the motor according to NEC and local codes. In the USA consult the National Electrical Code, Article 430 for information on grounding of motors and generators, and Article 250 for general information on grounding. In making the ground connection, the installer should make certain that there is a solid and permanent metallic connection between the ground point, the motor or generator terminal housing, and the motor or generator frame. In non-USA locations consult the appropriate national or local code applicable.

### ADJUSTMENT

The neutral is adjustable on some DC motors. AC motors have no adjustable parts.

### Noise

For specific sound power or pressure level information, contact your local Baldor representative.

### VIBRATION

This motor is balanced to NEMA MG1, Part 7 standard.

### BRUSHES (DC Motors)

Periodically, the brushes should be inspected and all brush dust blown out of the motor. If a brush is worn  $1/2$  (length specified in renewal parts data), replace the brushes. Reassemble and seat the new brushes using a brush seating stone. Be sure the rocker arm is set on the neutral mark.

**WARNING: Guards must be installed for rotating parts such as couplings, pulleys, external fans, and unused shaft extensions, should be permanently guarded to prevent accidental contact by personnel. Accidental contact with body parts or clothing can cause serious or fatal injury.**

**INSPECTION**

Before connecting the motor to an electrical supply, inspect for any damage resulting from shipment. Turn the shaft by hand to ensure free rotation. Motor leads must be isolated before the shaft will turn freely on permanent magnet motors.

**DRAIN PLUGS**

Condensation drain plugs are provided at four points on each endplate for various motor mounting configurations. For Washdown and totally enclosed, fan cooled or non-ventilated motors, the plugs in the lowest portion of the ends shields should be removed for operation (unless the motor has special stainless steel drains). All drains are located in the lowest portion of the ends shields.

**MOUNTING**

Mount the motor on a foundation sufficiently rigid to prevent excessive vibration. Grease lubricated ball bearing motors may be mounted with the feet at any angle. After careful alignment, bolt motor securely in place. Use shim to fill any unevenness in the foundation. Motor feet should sit solidly on the foundation before mounting bolts are tightened.

**IP (Ingress Protection)**

IP designations include two numerals, the first characteristic numeral is for ingress solid bodies and from dust. The second for ingress protection from liquid – water. Motors marked less than IP23 require additional protection from water.

**GUARDING**

After motor installation is complete, a guard of suitable dimensions must be constructed and installed around the motor/gearmotor. This guard must prevent personnel from coming in contact with any moving parts of the motor or drive assembly but must allow sufficient cooling air to pass over the motor.

If a motor mounted brake is installed, provide proper safeguards for personnel in case of brake failure. Brush inspection plates and electrical connection cover plates or lids, must be installed before operating the motor.

**STARTING**

Before starting motor remove all unused shaft keys and loose rotating parts to prevent them from flying off. Check direction of rotation before coupling motor to load. The motor should start quickly and run smoothly and with little noise. If the motor should fail to start the load may be too great for the motor, the voltage is low or the motor has been miswired. In any case immediately shut motor off and investigate the cause.

**ROTATION**

To reverse the direction of rotation, disconnect and lockout power and interchange any two of the three AC power leads for three phase motors. For two-phase four wire, disconnect and lockout power and interchange the AC line leads on any one phase. For two phase three wire, disconnect and lockout power and interchange phase one and phase two AC line leads.

**Maintenance Procedures**

**WARNING: Do not touch electrical connections before you first ensure that power has been disconnected. Electrical shock can cause serious or fatal injury.**

**WARNING: Surface temperatures of motor enclosures may reach temperatures which can cause discomfort or injury to personnel accidentally coming into contact with hot surfaces. Protection should be provided by the user to protect against accidental contact with hot surfaces. Failure to observe this precaution could result in bodily injury.**

**Lubrication Information**

This is a ball or roller bearing motor. The bearings have been lubricated at the factory. Motors that do not have regrease capability are factory lubricated for the normal life of the bearings. **Washdown motors can not be lubricated.**

**Lubricant**

Baldor motors are pregreased, normally with Mobil Polyrex EM unless stated on nameplate. Do not mix lubricants due to possible incompatibility. Look for signs of lubricant incompatibility, such as extreme souppiness visible from the grease relief area. If other greases are preferred, check with local Baldor representative for recommendations. **Relubrication Intervals (For motors with regrease capability)**

New motors that have been stored for a year or more should be relubricated. Lubrication is also recommended at these intervals.

**LUBRICATION INSTRUCTIONS**

Cleanliness is important in lubrication. Any grease used to lubricate anti friction bearings should be fresh and free from contamination. Properly clean the grease inlet area of the motor to prevent grease contamination.

1. Select service condition from Table 1.
2. Select lubrication frequency from Table 2.

**LUBRICATION PROCEDURE**

Bearings should be lubricated while stationary and the motor is warm.

1. Locate the grease inlet, clean the area, and replace the pipe plug with a grease fitting.
2. Locate and remove the grease drain plug, if provided.
3. Add the recommended volume of recommended lubricant until clean grease appears at the grease drain, at the grease relief, or along the shaft opening.
4. Replace the grease inlet plug and run the motor for two hours.
5. Replace the grease drain plug.

**SPECIAL APPLICATIONS**

For special temperature applications, consult your Baldor District Office.

**Table 1 Service Conditions**

| Severity of Service | Ambient Temperature Maximum   | Atmospheric Contamination             | Type of Bearing          |
|---------------------|-------------------------------|---------------------------------------|--------------------------|
| Standard            | 40° C                         | Clean, Little Corrosion               | Deep Groove Ball Bearing |
| Severe              | 50° C                         | Moderate dirt, Corrosion              | Ball Thrust, Roller      |
| Extreme             | >50° C* or Class H Insulation | Severe dirt, Abrasive dust, Corrosion | All Bearings             |
| Low Temperature     | <-30° C**                     |                                       |                          |

\* Special high temperature grease is recommended. \*\* Special low temperature grease is recommended.

**Table 2 Lubrication Frequency (Ball Bearings)**

| NEMA / (IEC) Frame Size      | Rated Speed - RPM |           |             |            |            |            |
|------------------------------|-------------------|-----------|-------------|------------|------------|------------|
|                              | 10000             | 6000      | 3600        | 1800       | 1200       | 900        |
| Up to 210 incl. (132)        | **                | 2700 Hrs. | 5500 Hrs.   | 12000 Hrs. | 18000 Hrs. | 22000 Hrs. |
| Over 210 to 280 incl. (180)  |                   | **        | 3600 Hrs.   | 9500 Hrs.  | 15000 Hrs. | 18000 Hrs. |
| Over 280 to 360 incl. (225)  |                   | **        | * 2200 Hrs. | 7400 Hrs.  | 12000 Hrs. | 15000 Hrs. |
| Over 360 to 5000 incl. (300) |                   | **        | *2200 Hrs.  | 3500 Hrs.  | 7400 Hrs.  | 10500 Hrs. |

\* Relubrication intervals are for ball bearings. For vertically mounted motors and roller bearings, divide the relubrication interval by 2.

\*\* For motors operating at speeds greater than 3600 RPM, contact Baldor for relubrication recommendations.

**Table 3 Lubrication Interval Multiplier**

| Severity of Service | Multiplier |
|---------------------|------------|
| Standard            | 1.0        |
| Severe              | 0.5        |
| Extreme             | 0.1        |
| Low Temperature     | 1.0        |

**Table 4 Amount of Grease to Add**

| Frame Size NEMA (IEC)        | Bearing Description (Largest bearing in each frame size) |         |            |                                      |  |     |      |
|------------------------------|--|---------|------------|--------------------------------------|--|-----|------|
|                              | Bearing  | OD D mm | Width B mm | Weight of grease to add ounce (gram) | Volume of grease to add inches <sup>3</sup> teaspoon |     |      |
| Up to 210 incl. (132)        |  | 6307    | 80         | 21                                   | 0.30 (8.4)   | 0.6 | 2.0  |
| Over 210 to 280 incl. (180)  |  | 6311    | 120        | 29                                   | 0.61 (17.4)  | 1.2 | 3.9  |
| Over 280 to 360 incl. (200)  |  | 6313    | 140        | 33                                   | 0.81 (23.1)  | 1.5 | 5.2  |
| Over 360 to 5000 incl. (300) |  | NU322   | 240        | 50                                   | 2.12 (60.0)  | 4.1 | 13.4 |

Weight in grams = 0.005 DB

**Typical IEC vs NEMA Lead Marking**

**Single Phase Non-Reversible**

Refer to the connection diagram provided on the Baldor motor.



**Single Phase Reversible**



**Dual Voltage Reversible**

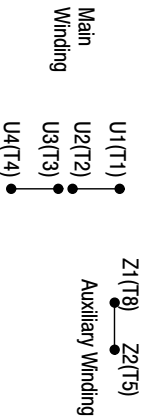

**Three Phase**

For single winding 3 phase motors, lead markings can be directly translated between IEC and NEMA designations.

For these motors, the lead markings are:  
 U1=T1 U2=T4 U3=T7 U4=T10  
 V1=T2 V2=T5 V3=T8 V4=T11  
 W1=T3 W2=T6 W3=T9 W4=T12

Refer to the connection diagram provided on the Baldor motor. Some examples are as follows:

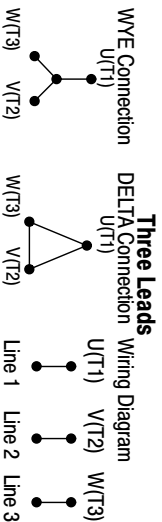

**DC Motors**

Lead markings can be translated between IEC and NEMA designations as follows:

|              | NEMA   | IEC    |
|--------------|--------|--------|
| Armature     | A1, A2 | A1, A2 |
| Series Field | S2, S2 | D1, D2 |
| Shunt Field  | F1, F2 | E1, E2 |

Refer to the connection diagram provided on the Baldor motor.

**Six Leads**

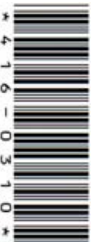
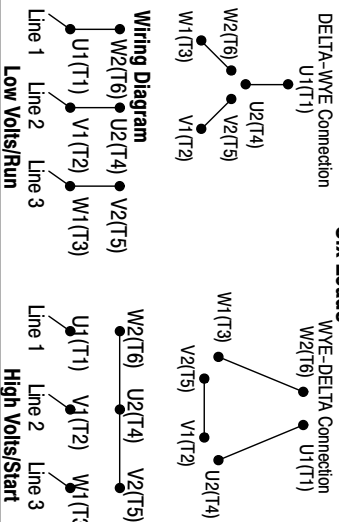

World Headquarters

P.O. Box 2400 Fort Smith, AR 72902-2400 USA Ph: (1) 479.646.4711, Fax: (1) 479.648.5792

www.baldor.com

© 2009 Baldor Electric Company  
 MN416

All rights reserved. Printed in USA  
 3/10

4 Installation & Maintenance

MN416