

BALDOR® • RELIANCE

Product Information Packet

ELECTRIC MOTOR WHOLESAL.COM

M3714T

10HP,1770RPM,3PH,60HZ,215T,3740M,TEFC,F1

Part Detail							
Revision:	E	Status:	INA/A	Change #:		Proprietary:	No
Type:	AC	Prod. Type:	3740M	Elec. Spec:	37WGS275	CD Diagram:	
Enclosure:	TEFC	Mfg Plant:		Mech. Spec:	37G813	Layout:	
Frame:	215T	Mounting:	F1	Poles:	04	Created Date:	07-18-2007
Base:	RG	Rotation:	R	Insulation:	F	Eff. Date:	01-13-2011
Leads:	9#14	Literature:		Elec. Diagram:		Replaced By:	

Nameplate NP1256L

CAT.NO.							
SPEC.	37G813S275H1						
HP	10						
VOLTS	208-230/460						
AMP	28-27/13.5						
RPM	1770						
FRAME	215T	HZ	60	PH	3		
SER.F.	1.15	CODE	K	DES	A	CLASS	F
NEMA-NOM-EFF	89.5	PF	77				
RATING	40C AMB-CONT						
CC	010A	USABLE AT 208V					
DE	6307	ODE	6206				
ENCL	TEFC	SN					

Parts List		
Part Number	Description	Quantity
SA160674	SA 37G813S275H1	1.000 EA
RA149260	RA 37G813S275H1	1.000 EA
37FN3002A01SP	EXFN, PLASTIC, 9.00 OD, 1.155 ID	1.000 EA
S/P101-000-000	EPACT PROCEDURES-FS PLANT-POLYREX EM, NO	1.000 EA
HW3200A01	3/8-16X3/4 I-BLT WELDED F/S	1.000 EA
37CB3006	37 CB CASTING W/1.38 LEAD HOLE @ 6:00	1.000 EA
37GS1000SP	GASKET, CONDUIT BOX STD., .06 THICK LEXI	1.000 EA
51XW2520A12	.25-20 X .75, TAPTITE II, HEX WSHR SLTD	2.000 EA
11XW1032G06	10-32 X .38, TAPTITE II, HEX WSHR SLTD U	1.000 EA
37EP3101A01SP	FR ENDPLATE,TEFC, 37 L&M, W/GREASER	1.000 EA
HW4500A01	1641B(ALEMITE)400 UNIV, GREASE FITT	1.000 EA
HW5100A06	W2420-025 WVY WSHR (WB)	1.000 EA
37EP3100A01SP	STD PU ENDPLATE, ENCL,37 "T"-307 BRG, W/	1.000 EA
HW4500A01	1641B(ALEMITE)400 UNIV, GREASE FITT	1.000 EA
XY3118A12	5/16-18 HEX NUT DIRECTIONAL SERRATION	4.000 EA
51XB1214A20	12-14X1.25 HXWSSLD SERTYB	1.000 EA
07FH4007SP	IEC FH W/GRSR, NOTCH @ 6:00 & 3 FAN CVR	1.000 EA
51XW1032A06	10-32 X .38, TAPTITE II, HEX WSHR SLTD S	3.000 EA
37CB4516	LIPPED LID FOR 37 FRAME NEC KOBX	1.000 EA
37GS1008SP	37 GS FOR CB LID - LEXIDE	1.000 EA
51XW0832A07	8-32 X .44, TAPTITE II, HEX WSHR SLTD SE	4.000 EA
HW2501F21	KEY, 5/16 SQ X 2.375	1.000 EA
HA7000A02	KEY RETAINER RING, 1 1/8 DIA, 1 3/8 DIA	1.000 EA
85XU0407S04	4X1/4 U DRIVE PIN STAINLESS	2.000 EA

Parts List (continued)		
Part Number	Description	Quantity
LB1115	LABEL,LIFTING DEVICE	1.000 EA
MJ1000A75	GREASE, POLYREX EM EXXON	0.050 LB
MG1000G27	PAINT- S9282E CHARCOAL GREY	0.028 GA
HA3104A17	5/16-18X13.250 T-BLT/OHIO	4.000 EA
LB1125C04	STD-E (STOCK CTN LABEL STD-E WITH FLAG)	1.000 EA
LC0005E01	CONN.DIA./WARNING LABEL (LC0005/LB1119)	1.000 EA
NP1256L	ALUM, UL CSA CC, W/O THERMAL, LASER	1.000 EA
GOPA1000	PACKAGING GROUP	1.000 EA

Accessories		
Part Number	Description	Multiplier
37-1304	C FACE KIT	A8

Performance Data at 460V, 60Hz, 10.0HP (Typical performance - Not guaranteed values)

General Characteristics							
Full Load Torque:	29.5 LB-FT			Start Configuration:	DOL		
No-Load Current:	7.31 Amps			Break-Down Torque:	121.0 LB-FT		
Line-line Res. @ 25°C.:	1.16 Ohms A Ph / 0.0 Ohms B Ph			Pull-Up Torque:	53.6 LB-FT		
Temp. Rise @ Rated Load:	78 C			Locked-Rotor Torque:	68.8 LB-FT		
Temp. Rise @ S.F. Load:	94 C			Starting Current:	107.0 Amps		
Load Characteristics							
% of Rated Load	25	50	75	100	125	150	S.F.
Power Factor:	36.0	58.0	70.0	77.0	81.0	83.0	79.0
Efficiency:	81.4	88.2	89.6	89.7	89.0	88.0	89.3
Speed:	1793.0	1785.0	1777.0	1769.0	1760.0	1751.0	1764.0
Line Amperes:	7.82	9.21	11.0	13.5	16.2	19.0	15.1

Performance Graph at 460V, 60Hz, 10.0HP Typical performance - Not guaranteed values

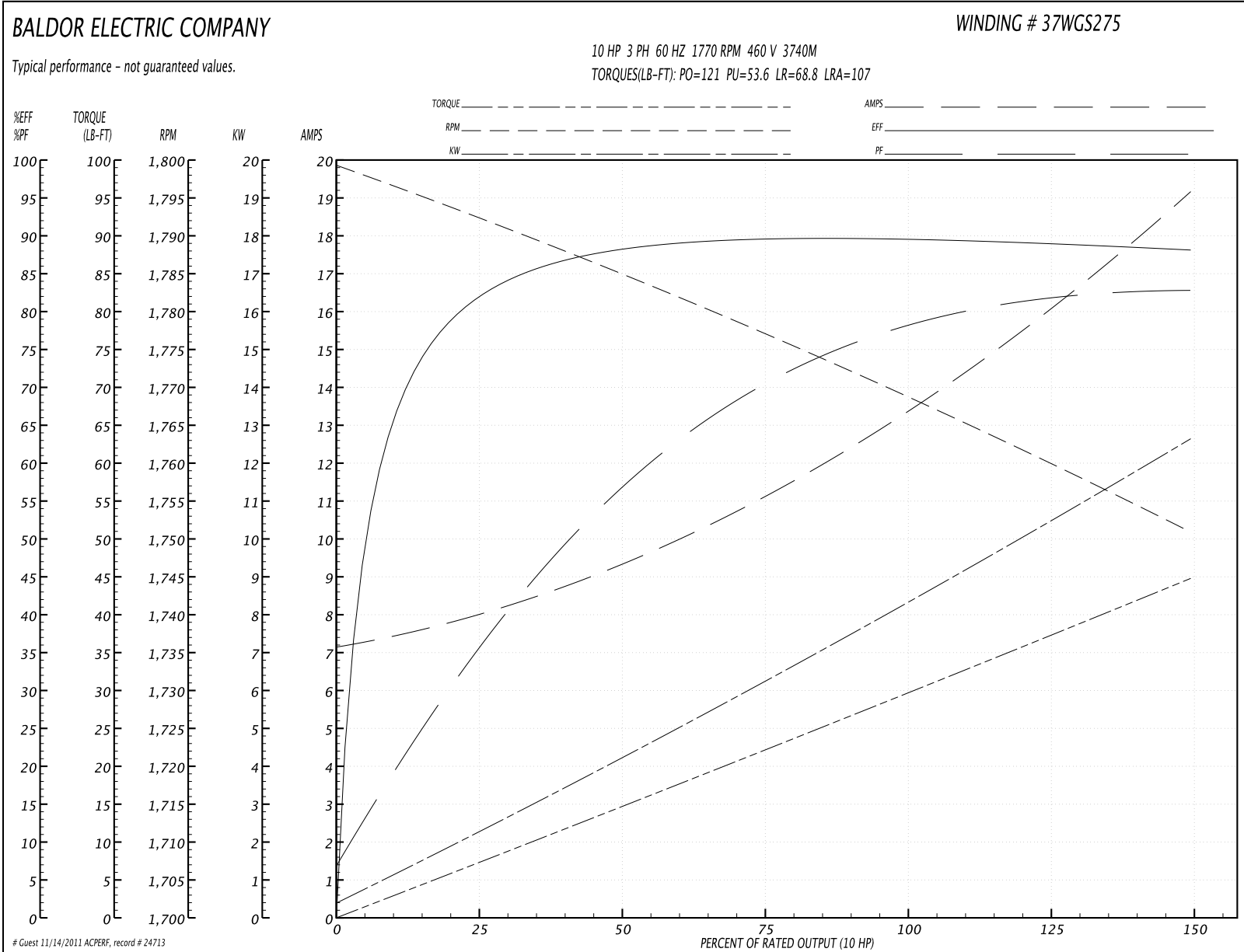

Performance Data at 230V, 60Hz, 10.0HP (Typical performance - Not guaranteed values)
General Characteristics

Full Load Torque:	29.5 LB-FT	Start Configuration:	DOL
No-Load Current:	14.6 Amps	Break-Down Torque:	121.0 LB-FT
Line-line Res. @ 25°C.:	0.288 Ohms A Ph / 0.0 Ohms B Ph	Pull-Up Torque:	53.6 LB-FT
Temp. Rise @ Rated Load:	78 C	Locked-Rotor Torque:	68.8 LB-FT
Temp. Rise @ S.F. Load:	92 C	Starting Current:	214.0 Amps

Load Characteristics

% of Rated Load	25	50	75	100	125	150	S.F.
Power Factor:	36.0	58.0	70.0	77.0	81.0	84.0	79.0
Efficiency:	81.4	88.5	89.4	89.6	89.0	88.1	89.2
Speed:	1793.0	1785.0	1777.0	1769.0	1760.0	1751.0	1764.0
Line Amperes:	15.6	18.4	22.0	27.0	32.4	38.0	30.2

Performance Graph at 230V, 60Hz, 10.0HP Typical performance - Not guaranteed values

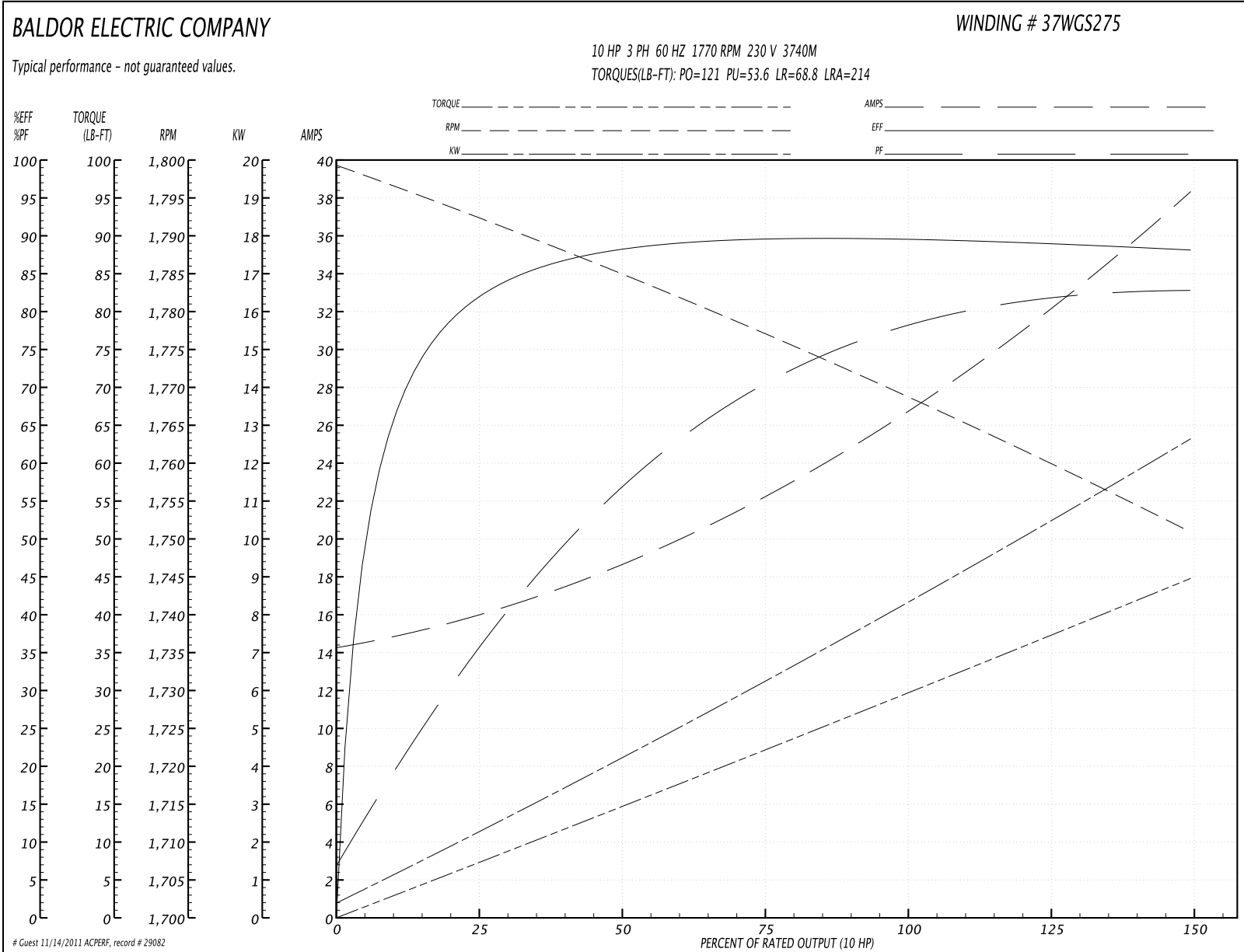

37LYG813

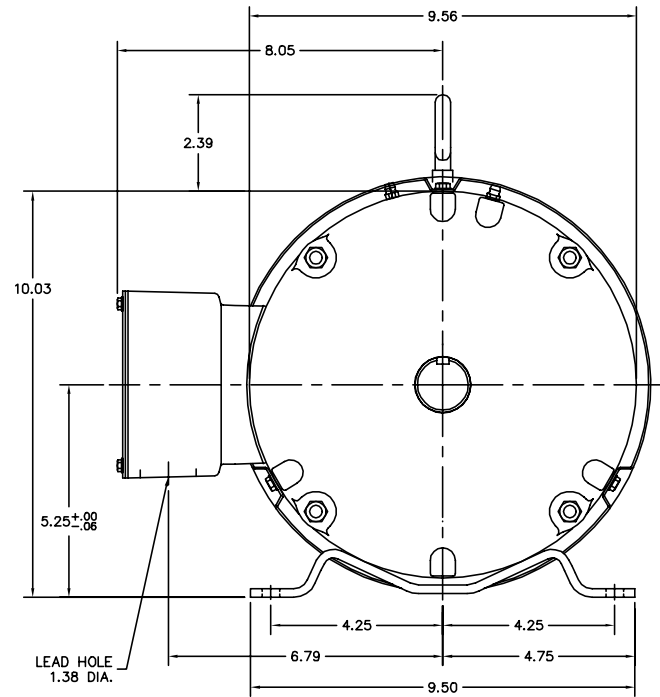
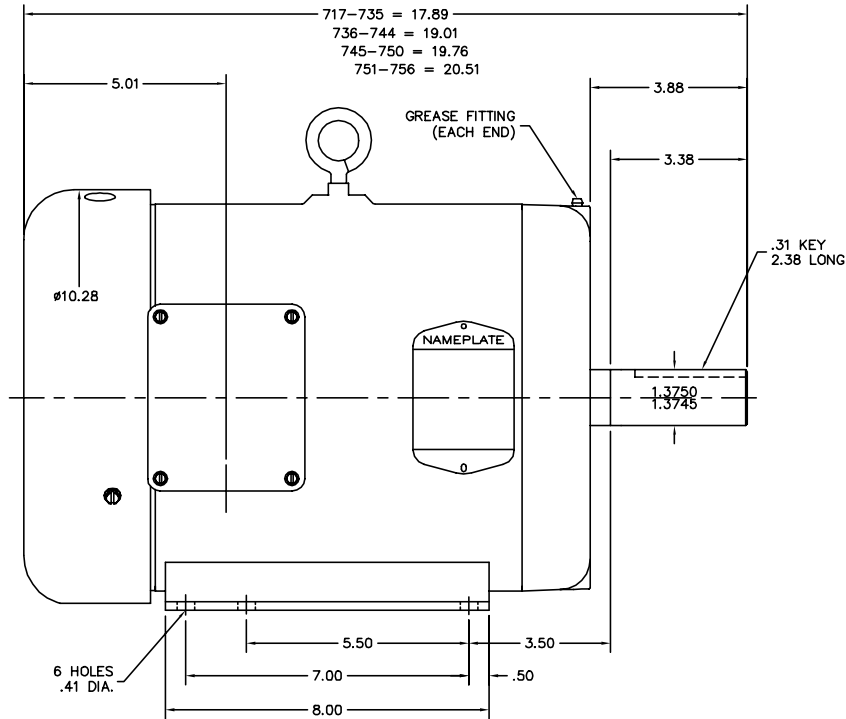

CUSTOMER IS RESPONSIBLE FOR DETERMINING THAT MOTOR PERFORMANCE IS SUITABLE IN THE APPLICATION.

REV. DESC: ADDED KOBX LEAD HOLE DIM			
REV. LTR: F	BY: RMP	REVISED: 16:06:08 09/08/2004	TDR: 342766
FILE: AAA00050966		REF: 37LYG813	
MTL: -			

BALDOR ELECTRIC Co.

HORZ 213-5T TEFC 37M W/EPACT SHOVE

37LYG813

CD0005

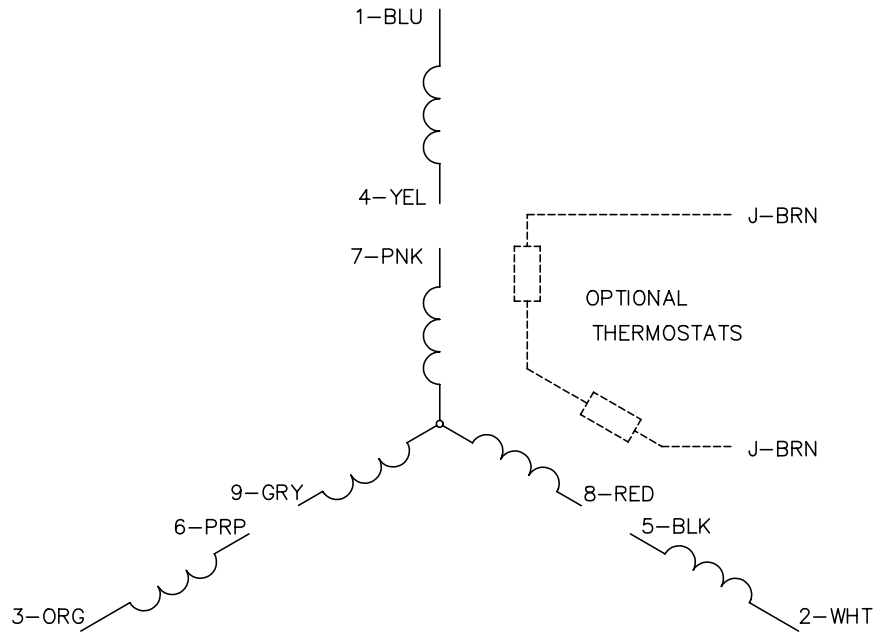

LOW VOLTAGE
(2Y)

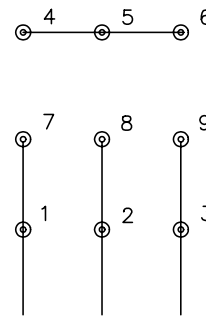

LINE

HIGH VOLTAGE
(1Y)

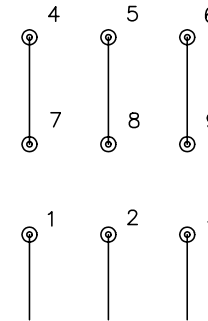

LINE

NOTES:

1. INTERCHANGE ANY TWO LINE LEADS TO REVERSE ROTATION.
2. OPTIONAL THERMOSTATS ARE PROVIDED WHEN SPECIFIED.
3. ACTUAL NUMBER OF INTERNAL PARALLEL CIRCUITS MAY BE A MULTIPLE OF THOSE SHOWN ABOVE.
4. LEAD COLORS ARE OPTIONAL. LEADS MUST ALWAYS BE NUMBERED AS SHOWN.

REV. DESC: REVISE TO SHOW OPTIONAL COLORS			
REV. LTR: E	BY: JLP	REVISED: 01/19/99 10:15	TDR: 0171435
90000		FILE: AAA00005140	MDL: -
		MTL: -	

BALDOR ELECTRIC Co.

3PH, DV, 9 LEADS

CD0005