

BALDOR® • RELIANCE

Product Information Packet

IDGM2500

.38HP,1700RPM,3PH,60HZ,K-1,2528M,TEFC,GM

Product Detail							
Revision:	Q	Status:	PRD/A	Change #:		Proprietary:	No
Type:	AC	Prod Type:	2528M	Elec. Spec:	25WGW289	CD Diagram:	CD0006A16
Enclosure	TEFC	Mfg Plant:		Mech Spec:		Layout:	25LYE418
Frame:	K	Mounting:		Poles:	04	Created Date:	
Base:		Rotation:	R	Insulation:	F	Eff. Date:	02-04-2008
Leads:	3#18					Replaced By:	
Nameplate NP1598A10							
CAT.NO.	IDGM2500	SER.NO					
SPEC.	25E418W289G1						
VOLTS	230						
MAG CUR	1.2	SL HZ	4.7				
RPM	1650	RPM MAX	3000				
HP	.38	HZ	60	PH	3	CLASS	F
FLA	1.5	WK2	0.0108				
RATING	40C AMB-CONT						
RATIO	5:1	OUT/RPM	330				
TORQ/IN LB	68						
VTSR	6:1						
APRV-CSA		APRV-CE		APRV-UL			

Parts List			
Product ID	Description	Quantity	List Price
SA086417	SA 25E418W289G1	1.000	354.00
RA079460	RA 25E418W289G1	1.000	295.00
SR000834	SR 25E418W289G1	1.000	150.00
MJ5019A01	ADHESIVE LOCTITE #680 WAS BAD4525	0.010	276.00
25EP2108A30	EP,25AC DE CL 60R8 RA INSIDE FACE MACHIN	1.000	87.00
HW5109A08	WASHER, WAVE SPRING FOR 30MM BORE SMALLE	1.000	3.00
HW5002A44	N5002-112 RET RING INTERNBEVELED F/6001	1.000	2.00
HW4600E07	SEAL,TRANSCOM #05112ASCW .500 X 1.125 X	1.000	2.00
25EP2113A04	EP,25AC ODE GP 42C EXR TEFC WFAN CVR MT	1.000	67.00
HA3100A11	THRUBOLT 10-32 X 6.750	2.000	4.00
HW1003A10	WASHER, #10 EX TH LK, ZN X	2.000	2.00
55XT0632G03	6-32 X 0.187 RD HD PHILLIPS, SERRATED	1.000	2.00
25FH4006A09	HSG,FAN EXR HSG SPL DEEP NOTCH WEXT 8-3	1.000	53.00
12XN0832A14	8-32 X 7/8 HEX HD SCREW	2.000	13.00
BFN3712	FAN,PM MOTOR STYLE R	1.000	19.00
HG0048A01G	HSG,K EX	1.000	63.00
BS0141A01G	HSG,K CAP W/FOOT OPEN SNAP RING 2X .2	1.000	60.00
BS0141A02G	HSG,K CAP W/FOOT CLOSED NO SNAP RING	1.000	55.00
HA4021A05	1/16 NPSF-HX SOC PIPE PLUG TAPER DRY SEA	1.000	2.00
BG6203A01	6203 OPEN,C3,SLUSH	1.000	6.00
BG6203A01	6203 OPEN,C3,SLUSH	1.000	6.00
HW5002A51	RET RING N5002 - 156 (WALDES) BEVELED 40	1.000	7.00
HW5100A03SP	WAVY WASHER (W1543-017)	1.000	2.00
15XM0832A10	SCREW, 8-32X .625, THREAD FORMING	8.000	2.00

Parts List (continued)			
Product ID	Description	Quantity	List Price
HW4600D29	SEAL, TCM #060871SC-G (.625" X .875"	1.000	12.00
RM1056	RUBBER SQUARE RING 2.739 I.D.	2.000	2.00
HA1194B01	BLADDER,CJK EXPANSION	1.000	15.00
15XM0632A04	SCREW, 6-32X .250, THREAD FORMING	3.000	2.00
RM1057	RUBBER SQUARE RING 1.424 I.D.	1.000	2.00
19XN1032A12	SCREW, HEX WASHER HEAD, #10-32 X .750	4.000	2.00
BMH1910	KEY 3/16X3/16X1 1/8 AUTO X	1.000	2.00
HA7000A04	KEY RETAINER 0.625 DIA SHAFTS	1.000	2.00
HA2250	SPACER, FOR "K" BOX WORM GEAR AUTOMATED	1.000	6.00
MG3000G01	EPOXY POWDER, GREY CHARCOAL	0.010	37.00
33CB3001-PA	33CB3001-PAINTED	1.000	16.00
34CB4500-PA	CONDUIT BOX LID, PAINTED	1.000	3.00
34GS1001SP	GASKET, STD CONDUIT BOX LID (LEXIDE)	1.000	2.00
33GS1006	GASKET CONDUIT BOX (LEXIDE)	1.000	2.00
84XN0832J06	8-32 X 3/8 SOC.HD CAP SCR BLK OXIDE	4.000	2.00
15XM0832A06	SCREW, 8-32X .375, THREAD FORMING	4.000	2.00
WM0054A07	WORM,K 5.0 INP	1.000	41.00
MJ1000B02	KLUBERSYNTH GH6-460 GEAR OIL	0.024	215.00
LB5040	INSTRUCTION TAG, AC & DC	1.000	2.00
NP1598A10	NP,AC INV AD NONE V CE CSA UL KW GEAR MO	1.000	
CPA1000	PACKING GROUP STD. SINGLE	1.000	7.00
LB1172A01	CUSTOM MTR CARTON LABEL LASER PRINTER	1.000	2.00

Performance Data at 230V, 60Hz, 0.38HP (Typical performance - Not guaranteed values)
General Characteristics

Full Load Torque:	228.6 OZ-IN	Start Configuration:	WYE
No-Load Current:	1.19 Amps	Break-Down Torque:	803.2 OZ-IN
Line-line Res. @ 25°C.:	13.578 Ohms A Ph / 0.0 Ohms B Ph	Pull-Up Torque:	720.0 OZ-IN
Temp. Rise @ Rated Load:	44°C	Locked-Rotor Torque:	801.4 OZ-IN
Temp. Rise @ S.F. Load:	57°C	Starting Current:	6.33 Amps

Load Characteristics

% of Rated Load:	25	50	75	100	125	150	S.F.
Power Factor:	30.0	43.0	55.0	64.0	72.0	78.0	72.0
Efficiency:	49.3	65.4	71.3	72.2	71.6	69.6	71.6
Speed:	1769.0	1743.0	1712.0	1678.0	1638.0	1589.0	1638.0
Line Amperes:	1.22	1.28	1.38	1.53	1.72	1.97	1.72

Performance Graph at 230V, 60Hz, 0.38HP (Typical performance - Not guaranteed values)

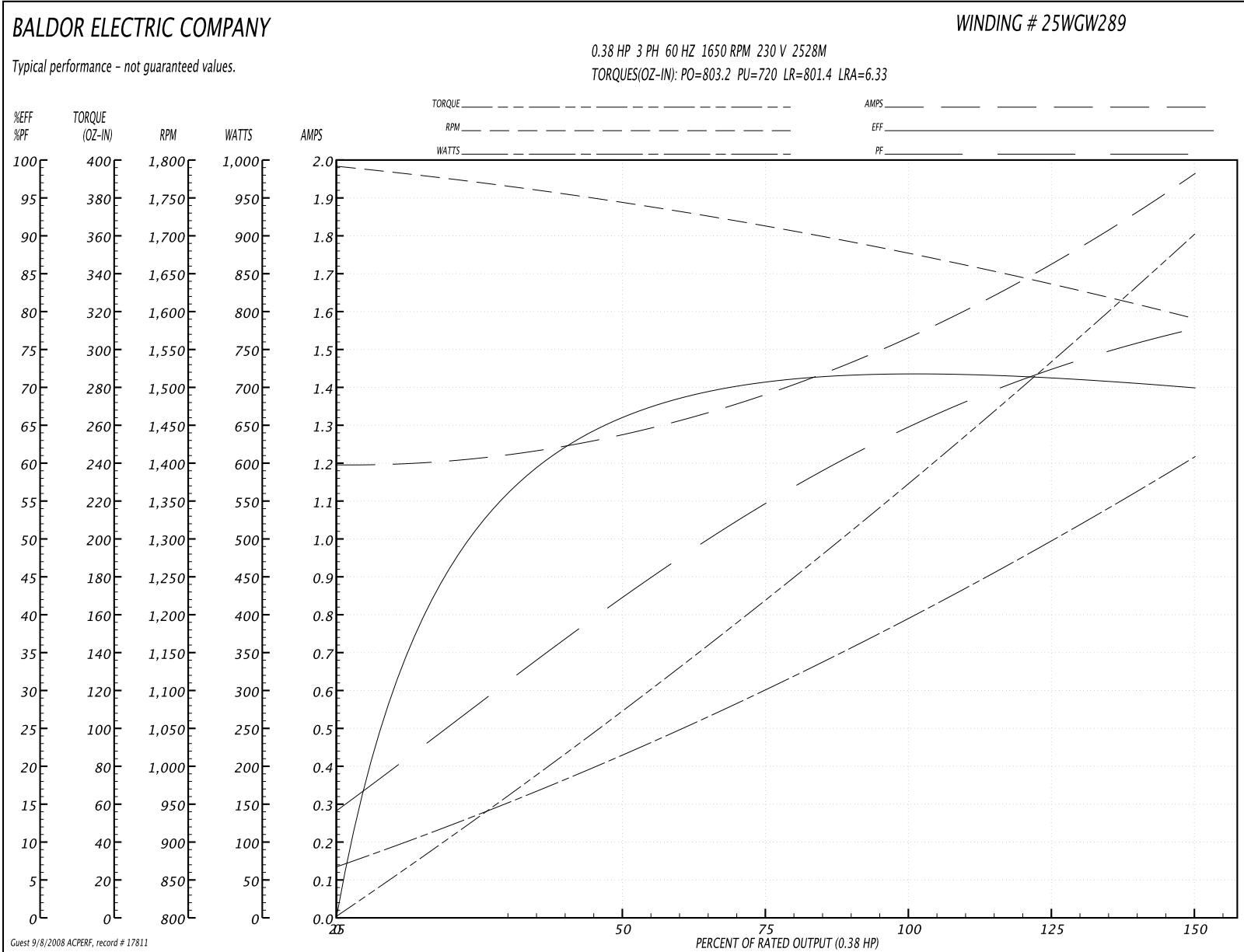

Performance Data at 230V, 60Hz, 0.38HP (Typical performance - Not guaranteed values)							
General Characteristics							
Full Load Torque:	228.6 OZ-IN			Start Configuration:	DOL		
No-Load Current:	1.19 Amps			Break-Down Torque:	803.2 OZ-IN		
Line-line Res. @ 25°C.:	13.577 Ohms A Ph / 0.0 Ohms B Ph			Pull-Up Torque:	720.0 OZ-IN		
Temp. Rise @ Rated Load:	68°C			Locked-Rotor Torque:	701.4 OZ-IN		
Temp. Rise @ S.F. Load:	87°C			Starting Current:	6.33 Amps		
Load Characteristics							
% of Rated Load:	25	50	75	100	125	150	S.F.
Power Factor:	30.0	43.0	55.0	64.0	72.0	78.0	72.0
Efficiency:	49.3	65.4	70.9	72.2	71.6	69.6	71.6
Speed:	1769.0	1743.0	1712.0	1678.0	1638.0	1589.0	1638.0
Line Amperes:	1.22	1.28	1.38	1.53	1.72	1.97	1.72

Performance Graph at 230V, 60Hz, 0.38HP (Typical performance - Not guaranteed values)

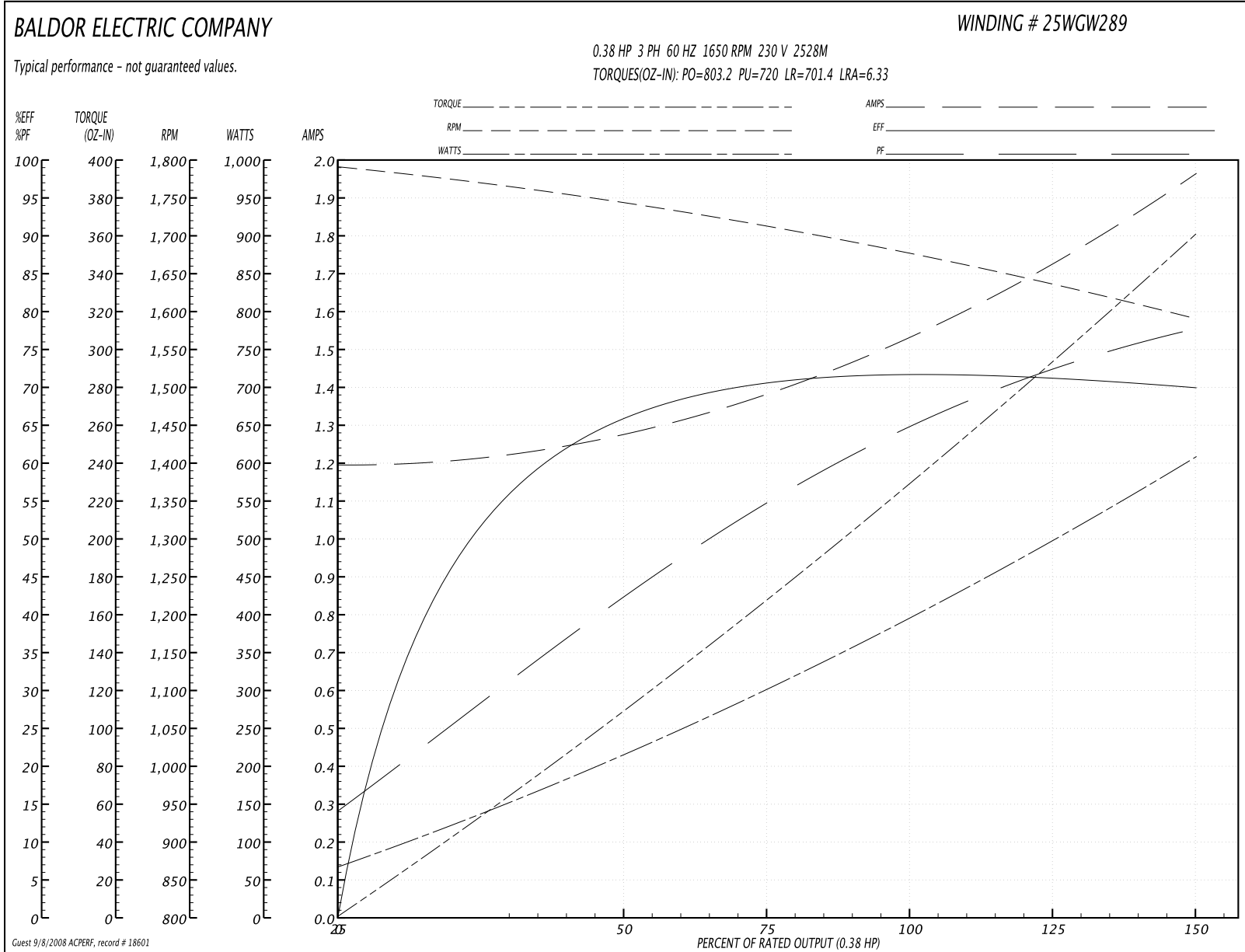

Performance Data at 230V, 60Hz, 0.306HP (Typical performance - Not guaranteed values)

General Characteristics

Full Load Torque:	57.0 LB-IN	Start Configuration:	DOL
No-Load Current:	1.24 Amps	Break-Down Torque:	1.0 LB-IN
Line-line Res. @ 25°C.:	13.577 Ohms A Ph / 0.0 Ohms B Ph	Pull-Up Torque:	1.0 LB-IN
Temp. Rise @ Rated Load:	0°C	Locked-Rotor Torque:	1.0 LB-IN
Temp. Rise @ S.F. Load:	0°C	Starting Current:	1.0 Amps

Load Characteristics

% of Rated Load:	25	50	75	100	125	150	S.F.
Power Factor:	29.0	42.0	52.0	61.0	68.0	73.0	68.0
Efficiency:	40.5	52.5	58.6	60.0	60.7	59.5	60.7
Speed:	353.7	348.9	343.8	338.9	331.6	324.6	332.0
Line Amperes:	1.28	1.35	1.44	1.57	1.71	1.9	1.71

Performance Graph at 230V, 60Hz, 0.306HP (Typical performance - Not guaranteed values)

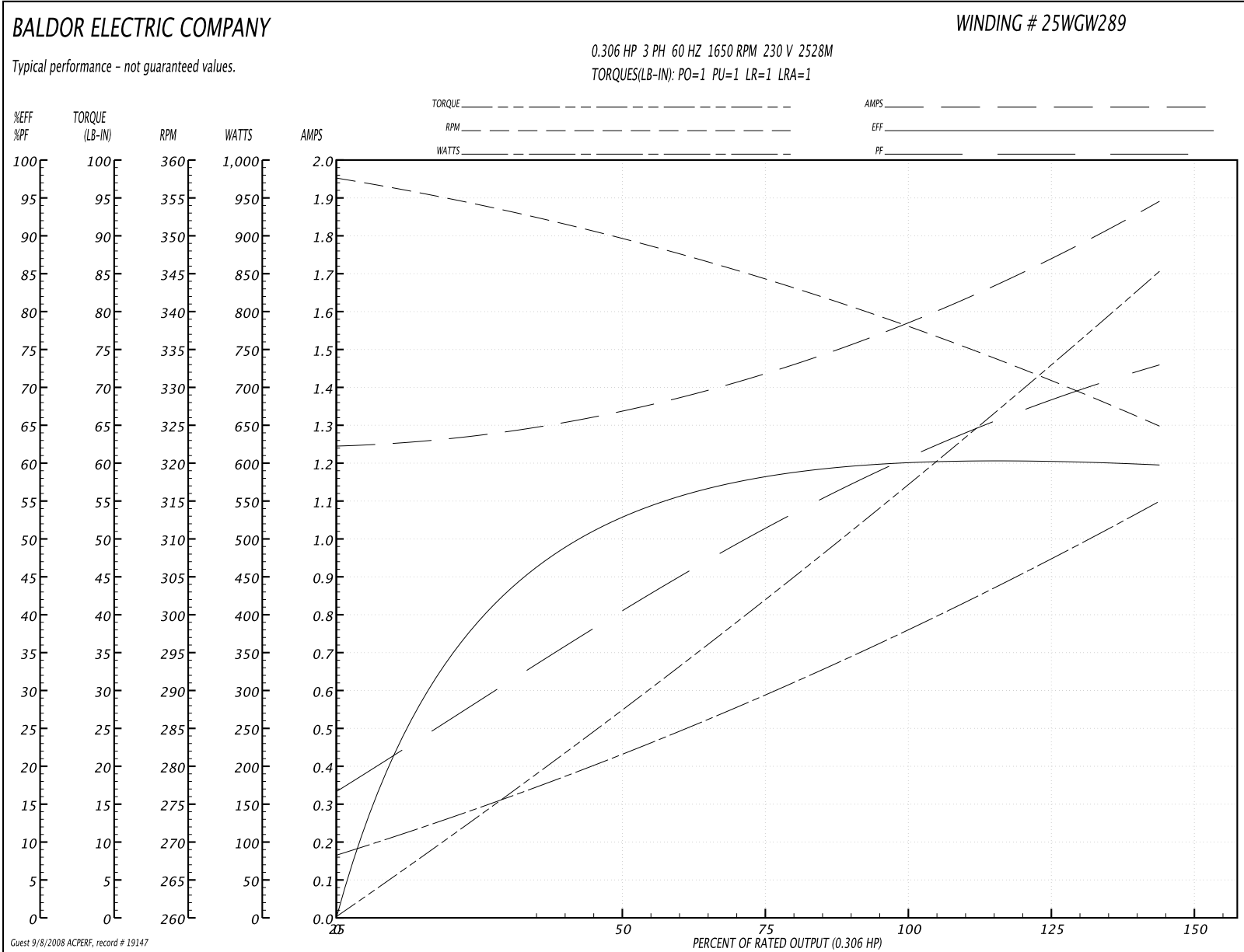

Performance Data at 230V, 60Hz, 0.279HP (Typical performance - Not guaranteed values)

General Characteristics							
Full Load Torque:	104.0 LB-IN			Start Configuration:	DOL		
No-Load Current:	1.24 Amps			Break-Down Torque:	1.0 LB-IN		
Line-line Res. @ 25°C.:	13.577 Ohms A Ph / 0.0 Ohms B Ph			Pull-Up Torque:	1.0 LB-IN		
Temp. Rise @ Rated Load:	0°C			Locked-Rotor Torque:	1.0 LB-IN		
Temp. Rise @ S.F. Load:	0°C			Starting Current:	1.0 Amps		
Load Characteristics							
% of Rated Load:	25	50	75	100	125	150	S.F.
Power Factor:	29.0	41.0	52.0	61.0	68.0	74.0	68.0
Efficiency:	37.6	50.5	53.1	55.2	54.5	51.9	54.5
Speed:	177.1	174.8	171.9	169.1	165.4	160.8	165.0
Line Amperes:	1.27	1.32	1.43	1.56	1.72	1.93	1.72

Performance Graph at 230V, 60Hz, 0.279HP (Typical performance - Not guaranteed values)

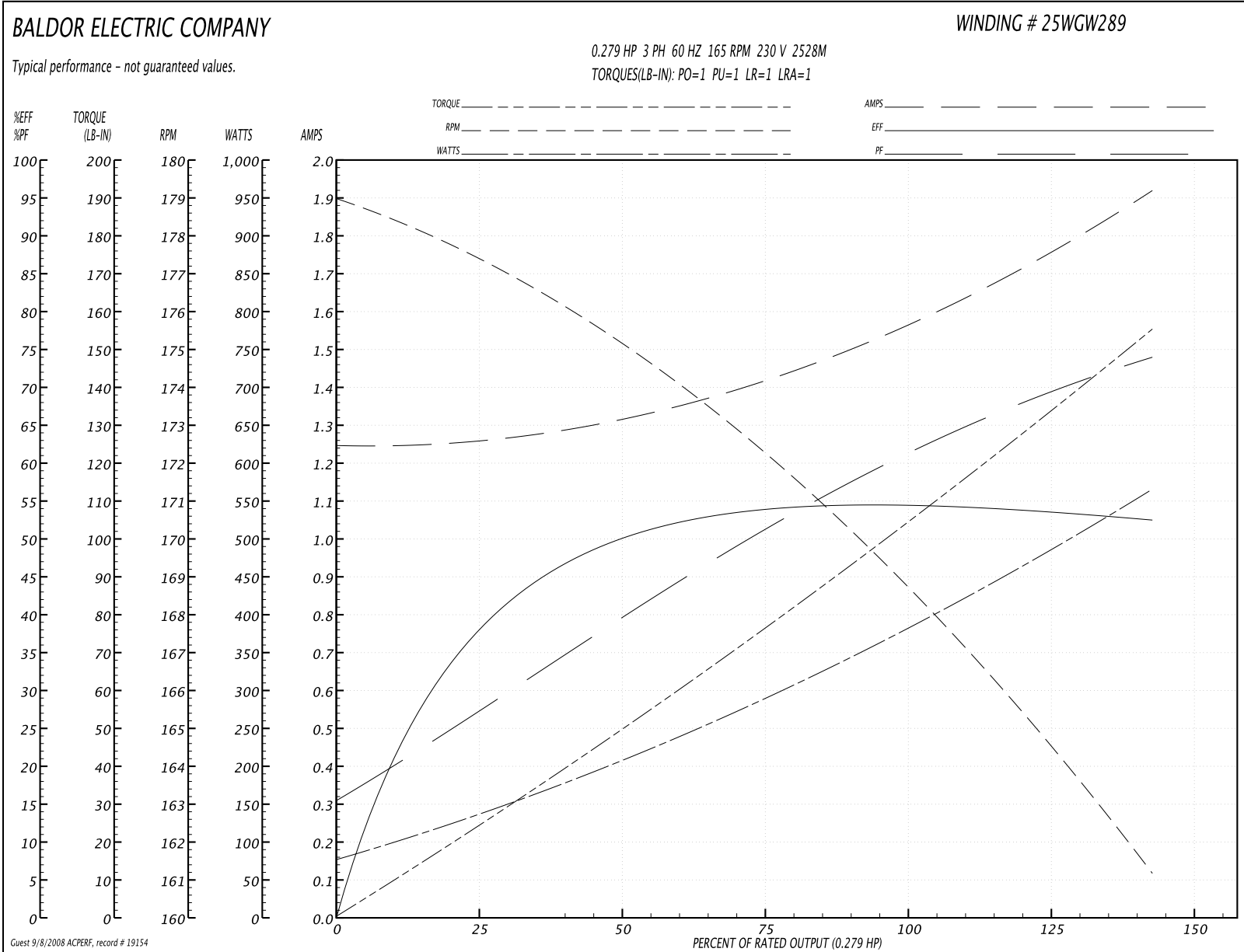

Performance Data at 230V, 60Hz, 0.176HP (Typical performance - Not guaranteed values)

General Characteristics							
Full Load Torque:	130.0 LB-IN			Start Configuration:	WYE		
No-Load Current:	1.25 Amps			Break-Down Torque:	1.0 LB-IN		
Line-line Res. @ 25°C.:	13.578 Ohms A Ph / 0.0 Ohms B Ph			Pull-Up Torque:	1.0 LB-IN		
Temp. Rise @ Rated Load:	0°C			Locked-Rotor Torque:	1.0 LB-IN		
Temp. Rise @ S.F. Load:	0°C			Starting Current:	1.0 Amps		
Load Characteristics							
% of Rated Load:	25	50	75	100	125	150	S.F.
Power Factor:	25.0	35.0	45.0	55.0	61.0	67.0	61.0
Efficiency:	27.8	37.4	40.8	41.7	43.1	42.7	43.1
Speed:	88.8	87.9	86.9	85.6	84.5	83.2	85.0
Line Amperes:	1.25	1.3	1.36	1.45	1.55	1.69	1.55

Performance Graph at 230V, 60Hz, 0.176HP (Typical performance - Not guaranteed values)

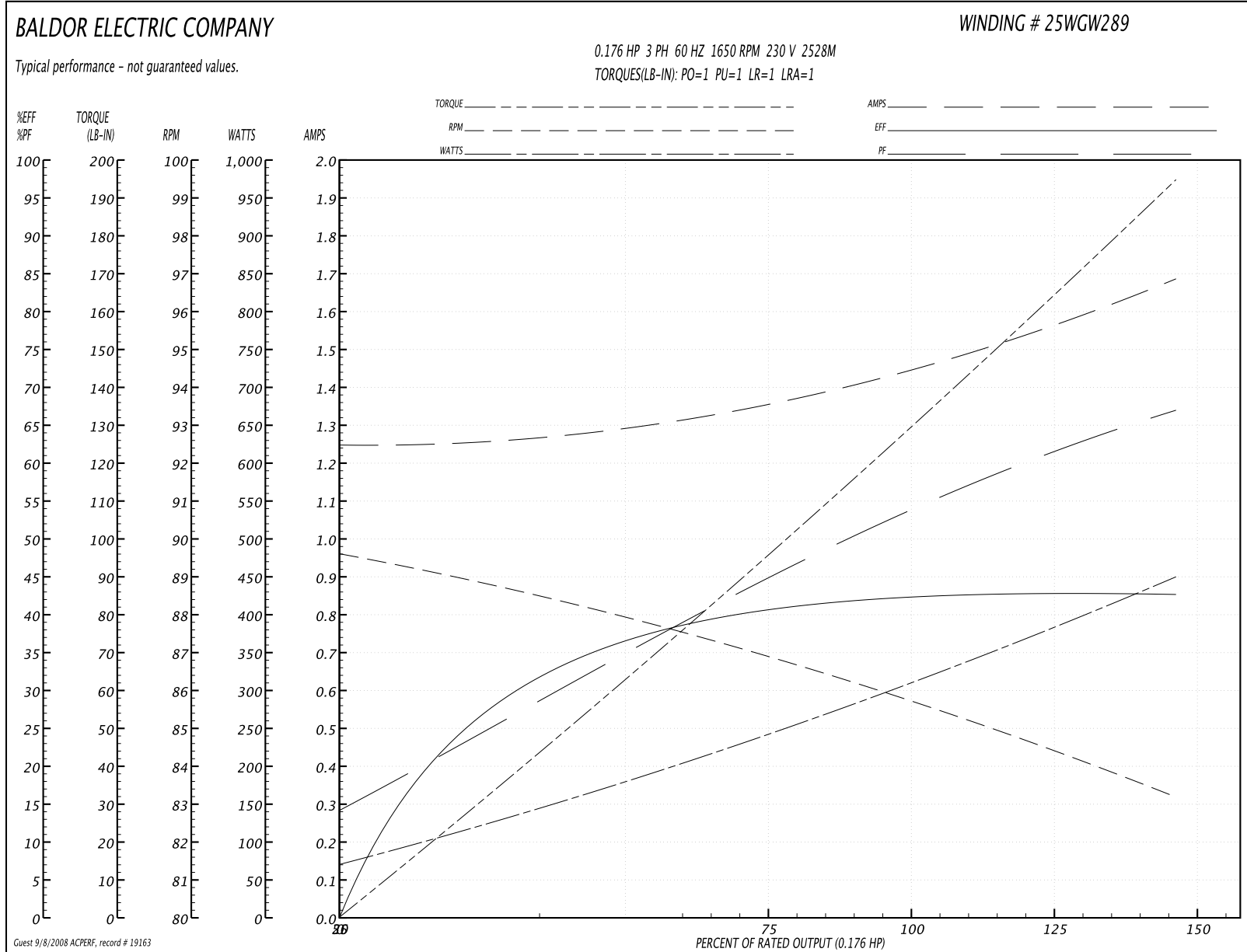

Performance Data at 230V, 60Hz, 0.27HP (Typical performance - Not guaranteed values)
General Characteristics

Full Load Torque:	100.0 LB-IN	Start Configuration:	WYE
No-Load Current:	1.24 Amps	Break-Down Torque:	1.0 LB-IN
Line-line Res. @ 25°C.:	12.854 Ohms A Ph / 0.0 Ohms B Ph	Pull-Up Torque:	1.0 LB-IN
Temp. Rise @ Rated Load:	0°C	Locked-Rotor Torque:	1.0 LB-IN
Temp. Rise @ S.F. Load:	0°C	Starting Current:	1.0 Amps

Load Characteristics

% of Rated Load:	25	50	75	100	125	150	S.F.
Power Factor:	26.0	36.0	45.0	53.0	63.0	66.0	63.0
Efficiency:	39.8	56.4	63.5	66.6	64.2	69.6	64.2
Speed:	177.2	175.1	173.0	170.5	167.7	165.2	168.0
Line Amperes:	1.26	1.29	1.35	1.43	1.53	1.65	1.53

Performance Graph at 230V, 60Hz, 0.27HP (Typical performance - Not guaranteed values)

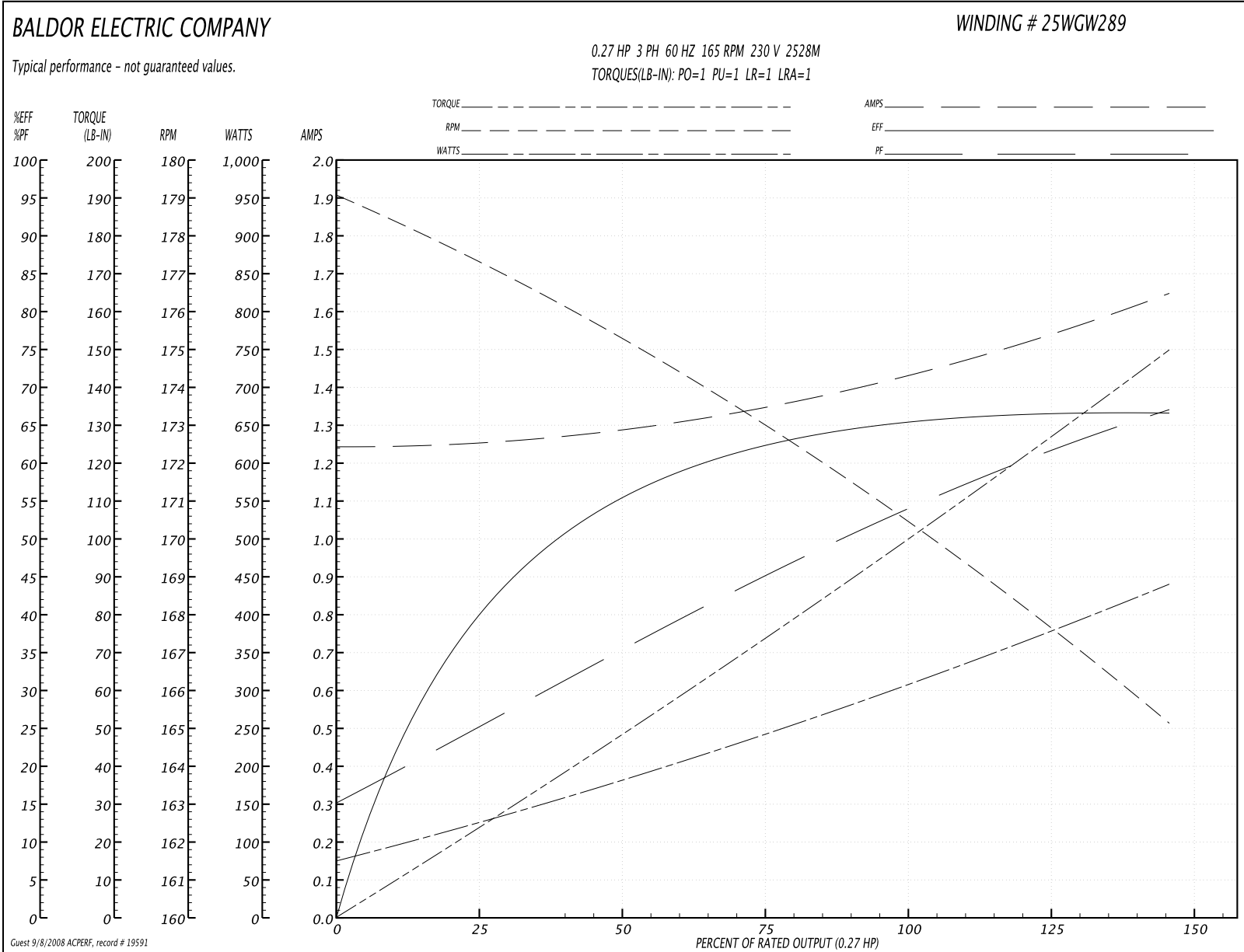

Performance Data at 230V, 60Hz, 0.38HP (Typical performance - Not guaranteed values)

General Characteristics

Full Load Torque:	228.6 OZ-IN	Start Configuration:	WYE
No-Load Current:	1.19 Amps	Break-Down Torque:	803.2 OZ-IN
Line-line Res. @ 25°C.:	13.578 Ohms A Ph / 0.0 Ohms B Ph	Pull-Up Torque:	720.0 OZ-IN
Temp. Rise @ Rated Load:	44°C	Locked-Rotor Torque:	801.4 OZ-IN
Temp. Rise @ S.F. Load:	57°C	Starting Current:	6.33 Amps

Load Characteristics

% of Rated Load:	25	50	75	100	125	150	S.F.
Power Factor:	30.0	43.0	55.0	64.0	72.0	78.0	72.0
Efficiency:	49.3	65.4	71.3	72.2	71.6	69.6	71.6
Speed:	1769.0	1743.0	1712.0	1678.0	1638.0	1589.0	1638.0
Line Amperes:	1.22	1.28	1.38	1.53	1.72	1.97	1.72

Performance Graph at 230V, 60Hz, 0.38HP (Typical performance - Not guaranteed values)

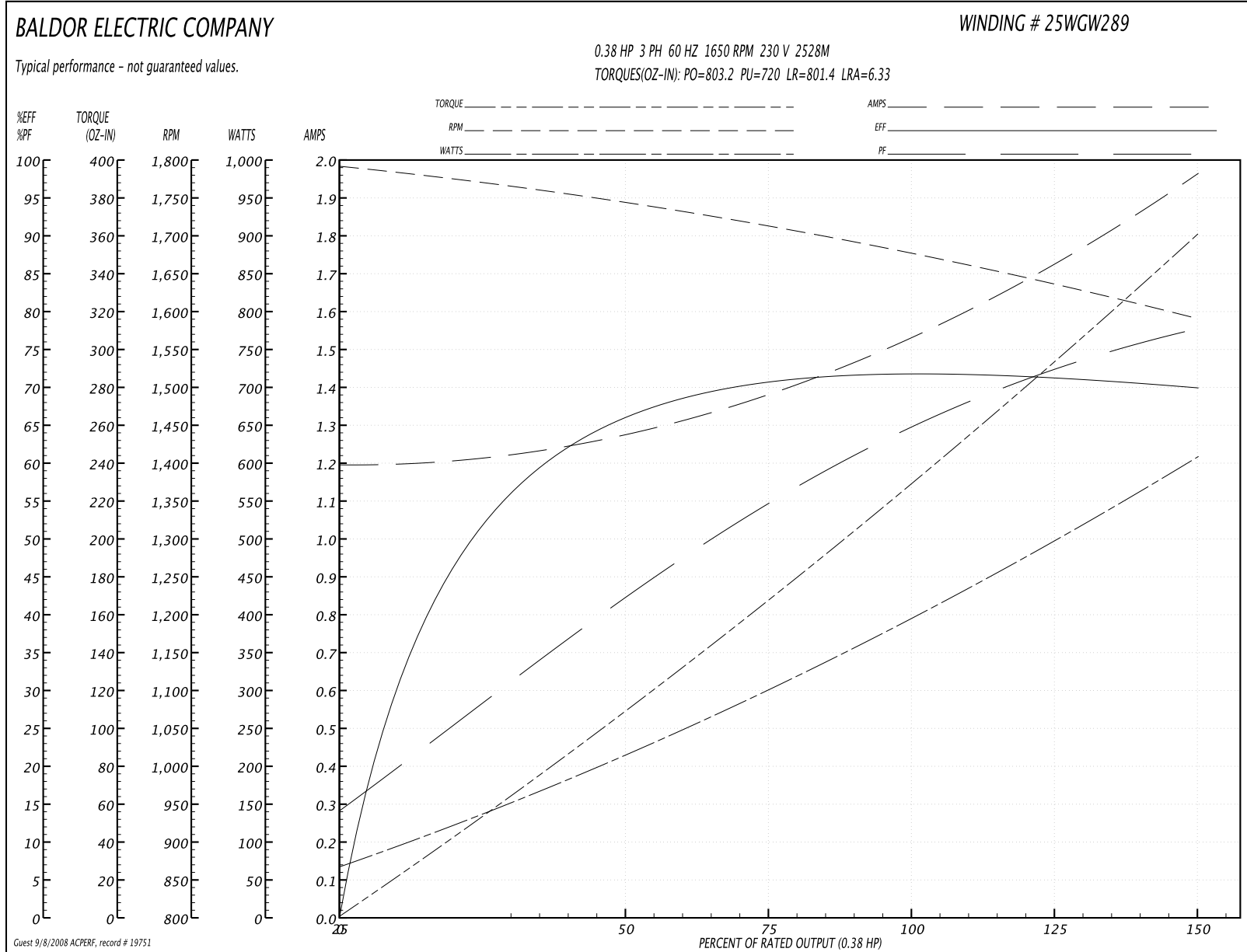

Performance Data at 230V, 60Hz, 0.295HP (Typical performance - Not guaranteed values)

General Characteristics							
Full Load Torque:	110.0 LB-IN			Start Configuration:	WYE		
No-Load Current:	1.25 Amps			Break-Down Torque:	1.0 LB-IN		
Line-line Res. @ 25°C.:	13.578 Ohms A Ph / 0.0 Ohms B Ph			Pull-Up Torque:	1.0 LB-IN		
Temp. Rise @ Rated Load:	0°C			Locked-Rotor Torque:	1.0 LB-IN		
Temp. Rise @ S.F. Load:	0°C			Starting Current:	1.0 Amps		
Load Characteristics							
% of Rated Load:	25	50	75	100	125	150	S.F.
Power Factor:	28.0	40.0	49.0	58.0	64.0	70.0	64.0
Efficiency:	39.9	53.8	60.9	63.8	65.1	65.1	65.1
Speed:	176.8	174.2	171.7	169.0	166.2	163.2	166.0
Line Amperes:	1.27	1.32	1.4	1.5	1.62	1.76	1.62

Performance Graph at 230V, 60Hz, 0.295HP (Typical performance - Not guaranteed values)

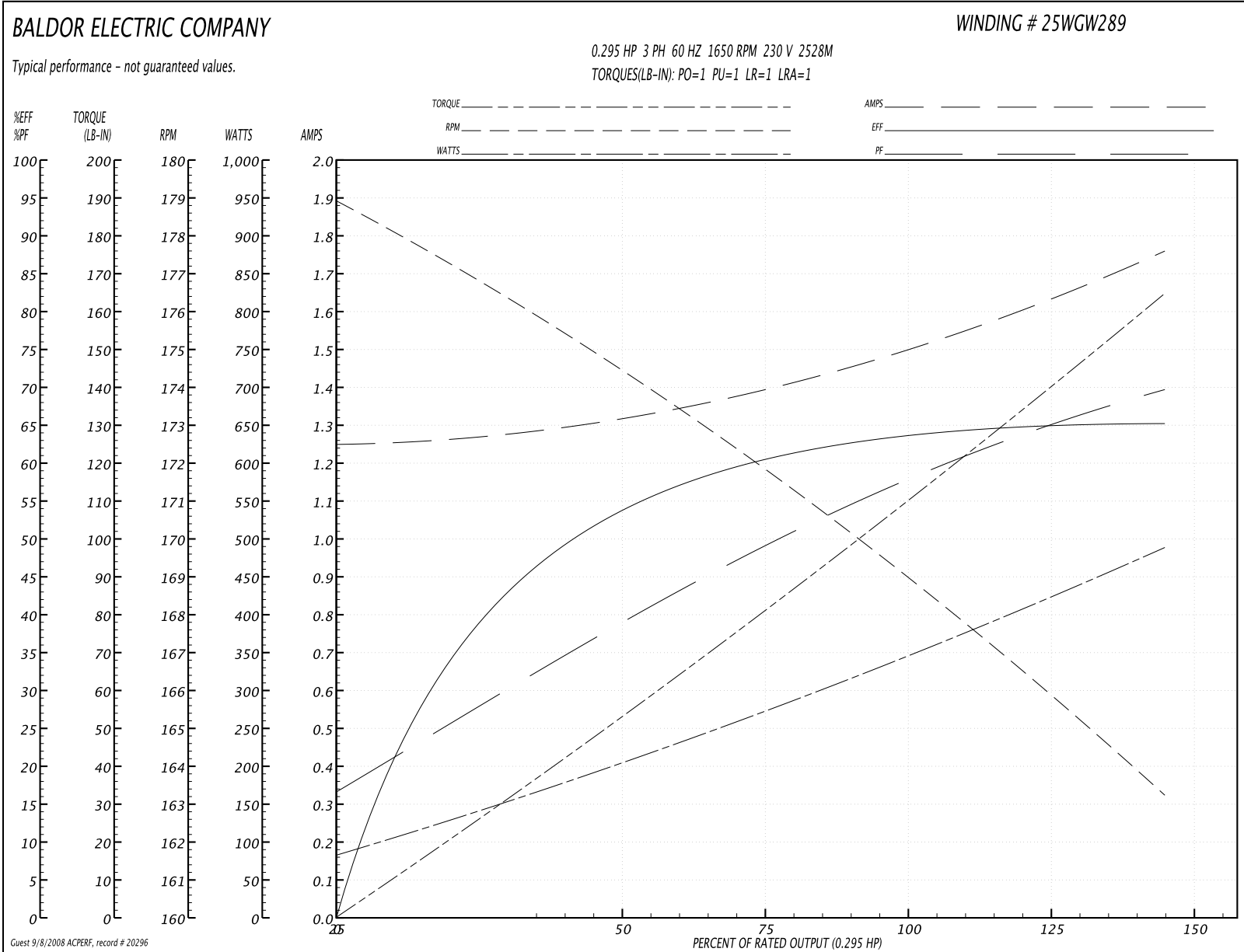

Performance Data at 230V, 60Hz, 0.33HP (Typical performance - Not guaranteed values)							
General Characteristics							
Full Load Torque:	197.4 OZ-IN			Start Configuration:	WYE		
No-Load Current:	1.25 Amps			Break-Down Torque:	864.0 OZ-IN		
Line-line Res. @ 25°C.:	13.404 Ohms A Ph / 0.0 Ohms B Ph			Pull-Up Torque:	816.0 OZ-IN		
Temp. Rise @ Rated Load:	0°C			Locked-Rotor Torque:	929.7 OZ-IN		
Temp. Rise @ S.F. Load:	0°C			Starting Current:	6.91 Amps		
Load Characteristics							
% of Rated Load:	25	50	75	100	125	150	S.F.
Power Factor:	26.0	38.0	49.0	58.0	66.0	73.0	66.0
Efficiency:	47.6	61.7	67.7	70.2	70.7	69.7	70.7
Speed:	1775.0	1748.0	1723.0	1690.0	1656.0	1621.0	1656.0
Line Amperes:	1.26	1.31	1.4	1.51	1.65	1.83	1.65

Performance Graph at 230V, 60Hz, 0.33HP (Typical performance - Not guaranteed values)

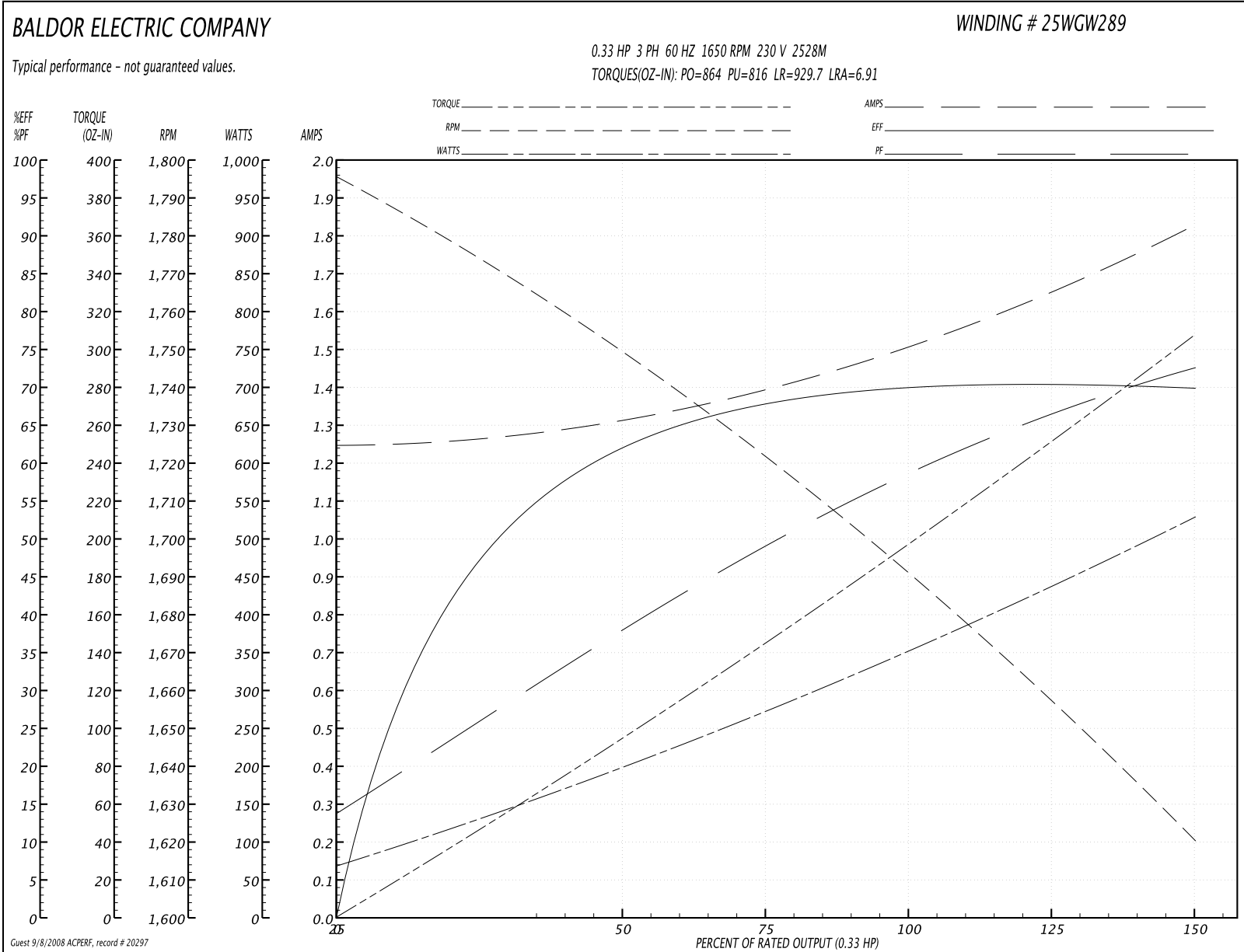

25LYE418

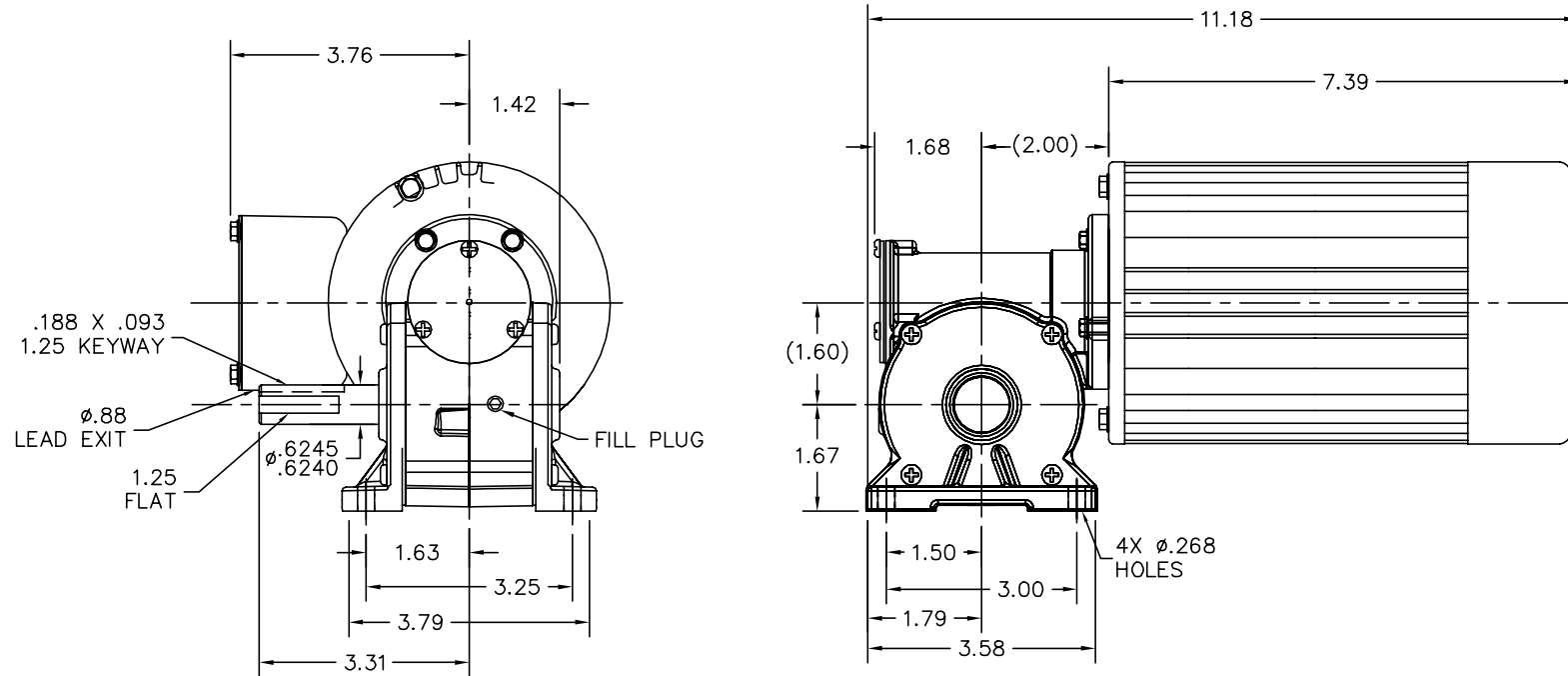

CUSTOMER IS RESPONSIBLE FOR DETERMINING THAT MOTOR PERFORMANCE IS SUITABLE IN THE APPLICATION.

REV. DESC: CORRECT VIEW OF FILL PLUG		
REV. LTR: E	VERSION: 04	TDR: 000000394726
	FILE: \CKA\00018\947	REVISED: 10:18:08 04/20/2006
	MTL: -	BY: CKRONSO

BALDOR ELECTRIC Co.

LY,25AC K EXR TEFC INVERTER DUTY

25LYE418

25LYE418

CD0006A16

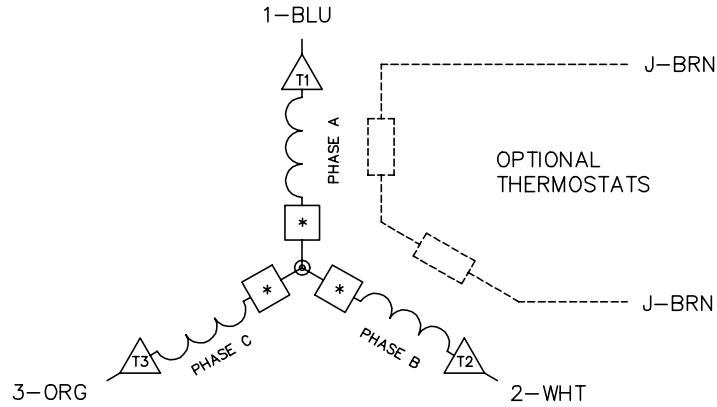

TYPICAL WYE-CONNECTED MOTOR

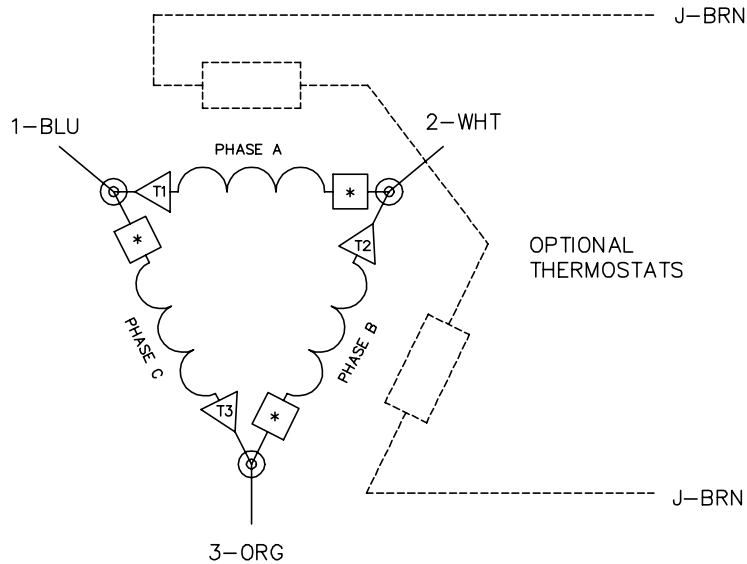

TYPICAL DELTA-CONNECTED MOTOR



NOTES:

1. THREE LEAD MOTOR MAY BE EITHER WYE CONNECTED OR DELTA CONNECTED.
2. INTERCHANGE ANY TWO LINE LEADS TO REVERSE ROTATION.
3. OPTIONAL THERMOSTATS ARE PROVIDED WHEN SPECIFIED.
4. ACTUAL NUMBER OF INTERNAL PARALLEL CIRCUITS MAY VARY.
5. LEAD COLORS ARE OPTIONAL. LEADS MUST BE NUMBERED AS SHOWN.
6.  = MAGNET WIRE COIL END WITH I.D. NUMBER.
-  = MAGNET WIRE COIL END WITH I.D. SYMBOL.
7. REFERENCE CW PRINT FOR NEST TO NEST CROSSOVER CONNECTIONS.

REV. DESC: ADD NOTE 7 PER JF

REV. LTR: B

VERSION: 02

TDR: 000000444134

91V900000

FILE: \CKA\00024\426

REVISED: 12:18:17 10/23/2007

MTL: -

BY: CKRONSO

BALDOR • DODGE • RELIANCE

3PH, SV, 3 LEADS, WYE OR DELTA CONNECTED, CK

CD0006A16